



Applications

Shackles are used in lifting operations and static systems as removable links to connect (steel) wire rope, chain and other fittings. Screw pin shackles are used mainly for non-permanent applications. Safety bolt shackles are used for long-term or permanent applications or where the load may slide on the pin causing rotation of the pin.

Chain- or dee shackles are mainly used on one-leg systems whereas anchor- or bow shackles are mainly used on multi-leg systems.

Range

Van Beest offers a wide range of bow and dee shackles for a wide variety of applications. The range stretches from WLL 0.33 t to 1550 t. This provides our customers with a very extensive range to choose a shackle that suits their application best. Most of the shackles are directly available from stock. Furthermore, shackles can be supplied to many standards such as the US Federal Specification RR-C-271, EN 13889, British Standard 3032, DIN 82101, DIN 82016 etc. Additionally we offer a wide range of general commercial shackles, which are not suitable for lifting but merely for fixing purposes.

Design

All Van Beest shackles have a specific design for a specific application.

Some examples are:

- Green Pin® Super shackles which are made out of grade 8 steel. They are designed to be used in confined spaces. The higher material strength is used to reduce the physical dimensions of the product whilst maintaining its WLL and functionality of the product;
- Green Pin® Polar shackles are for use in extreme climatic conditions with material properties guaranteed up to temperatures of -40°C;
- Green Pin® Sling shackles are designed to provide a better radius to the sling it lifts. A bigger radius increases the life span of the sling significantly;
- Another example of functional design is a shackle pin with a square sunken hole. Because of the flat head there is less risk of the shackle getting caught in a net or a line.

These are all examples of highly functional designs, to optimize the use of the Van Beest shackles in daily use.

Shackles used for lifting applications are generally marked with:

- Working Load Limit ■ e.g. WLL 25 T
- manufacturer's symbol ■ e.g. GP
- traceability code ■ e.g. HA indicating a particular batch
- steel grade ■ e.g. 4, 6, 8
- CE conformity code (Conformité Européenne) ■ CE

Van Beest Green Pin® shackles meet all relevant requirements of the Machinery Directive 2006/42/EC and its latest amendments.

Finish

Shackles supplied by Van Beest can be hot dipped galvanized, electro-galvanized, painted or self coloured, depending on the type of shackle and its application.

You can find the finish of each type of shackle in the product section further on.

Certification

Upon request at time of order, all load rated shackles can be supplied with any of the following documents or certificates:

Free of Charge:

2.1 2.2 3.1 MTC^a DNV 2.7-1^a DNV 2.7-1^b DNV 2.22 CE

With additional Charges:

MTC^b MPI^a MPI^b US^a US^b BL

On request the proof load test certificates can be supplied surveyed by an official classification society, such as LROS, DNV GL, BV, ABS or any other officially certified inspection body.

Please verify your certification requirements with Van Beest at time of order.





Green Pin® standard shackles and Green Pin® Polar shackles are DNV type approved. These shackles carry two DNV type approval certificates that show compliance with:

- DNV 2.7-1 Offshore Containers
- EN 12079-2 Offshore containers and associated lifting sets
- EN 13889 Forged steel shackles for general lifting purposes
- IMO/MSC Circular 860
- US Federal Specification RR-C-271
- DNV Standard for Certification No. 2.7-3 Portable Offshore Units
- DNV Standard for Certification No. 2.22 Lifting Appliances

The certificates S-7593 and S-7925 confirm that Green Pin® standard shackles and Green Pin® Polar shackles meet the requirements set in the latest version of the above mentioned DNV standards.

Testing

Generally load rated products are Proofload tested, and certificates can be supplied upon request. For specific information on certificates we refer to the separate paragraph on certification.

Green Pin® shackles are Proofload tested at the following loads:

working load limit	Green Pin® standard shackles polar shackles heavy duty shackles proof load	Green Pin® super shackles proof load	Green Pin® sling shackles proof load
t	t	t	t
0,33	0,66		
0,5	1		
0,75	1,5		
1	2		
1,5	3		
2	4		
3,25	6,5		
3,3		6,6	
4,75	9,5		
5		10	
6,5	13		
7		14	14
8,5	17		
9,5	19	19	
12	24		
12,5		25	25
13,5	27		
15		30	
17	34		
18		36	36
21		42	
25	50		
30		60	60
35	70		
40		80	80
42,5	85		
55	110	110	110
75			112,5
85	170	170	
120	180	240	
125			187,5
150	225	225	225
175		262,5	
200	300		300
250	375		375
300	450		450
400	600		532
500	750		665
600	900		798
700	1050		931
800	1200		1064
900	1350		1197
1000	1500		1330
1250	1875		1663
1500	2250		
1550			2061,5

1
2
3
4
5
6
7
8
9
10
11
12
13
14
15
16
17
18
19
20

Instructions for use

Select the correct type and WLL of shackle and WLL for the particular application. If extreme circumstances or shock loading may occur, this must be well taken into account when selecting the correct shackle. Please note that commercial shackles are not to be used for lifting applications.

Shackles should be inspected before use to ensure that:

- all markings are legible;
- the body and pin are both of the same brand and type;
- the body and pin are both of the correct size;
- never use a safety bolt type shackle without using a securing pin;
- the pin, nut, cotter pin, or any other locking system cannot vibrate out of position;
- the threads of the pin and the body are undamaged;
- the body and the pin are not distorted or unduly worn;
- the body and pin are free from nicks, gouges, cracks and corrosion;
- shackles may not be heat treated as this may affect their WLL;
- never modify, repair or reshape a shackle by machining, welding, heating or bending as this will affect the WLL.

Assembly

Ensure that the pin is correctly screwed into the shackle eye: tighten it hand-tight, then secure it using a wrench or other suitable tool so that the collar of the pin is fully seated against the shackle eye. Ensure that the pin is of the correct length so that it penetrates the full depth of the threaded eye and the collar of the pin seats against the surface of the shackle eye.

Incorrect seating of the pin may be caused by a bent pin, too tight fitting thread or misalignment of the pin holes. Do not use the shackle under these circumstances. Never replace a shackle pin except with one of the same brand, type, make and size to ensure the shackle maintains its original WLL.

Make sure that the shackle is supporting the load correctly, i.e. along the axis of the shackle body centerline. Avoid bending loads, unstable loads and overloads.

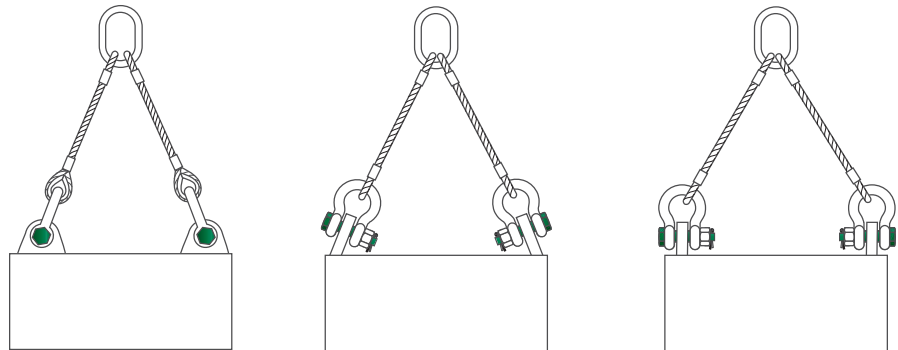

ONLY WITH REDUCED WLL

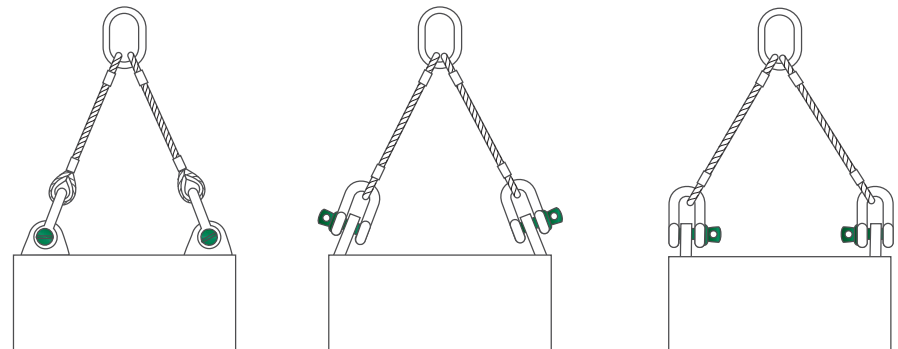

ONLY WITH REDUCED WLL

Side loads

Side loads should be avoided, as the products are not designed for this purpose. If side loads cannot be avoided, the WLL of the shackle must be reduced:

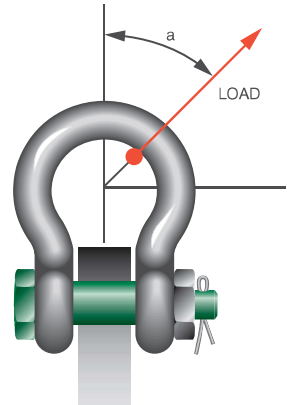
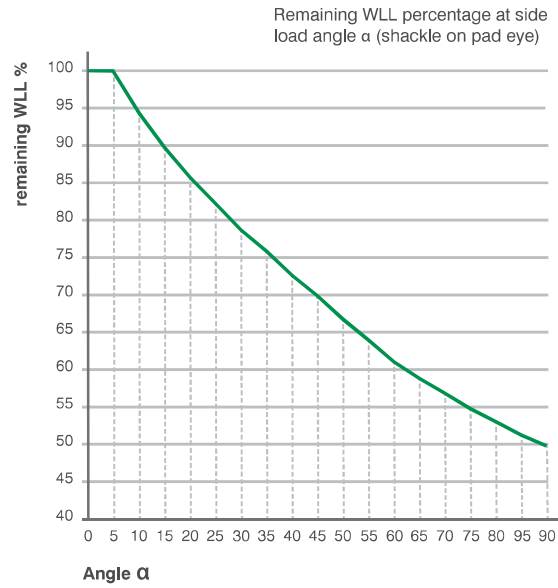

This graph is valid for all Green Pin® shackles, except P-6033 (Sling shackles). If you want to apply a side load on a Green Pin® Sling shackle, please contact Van Beest.

In-line lifting is considered to be a load perpendicular to the pin and in the plane of the bow. The load angles in the graph represent the deviating angles from in-line loading.

When connecting shackles to multi-leg slings, consider the effect of the angle between the legs of the sling. As the angle increases, so does the load in the sling leg and consequently in any shackle attached to that leg.

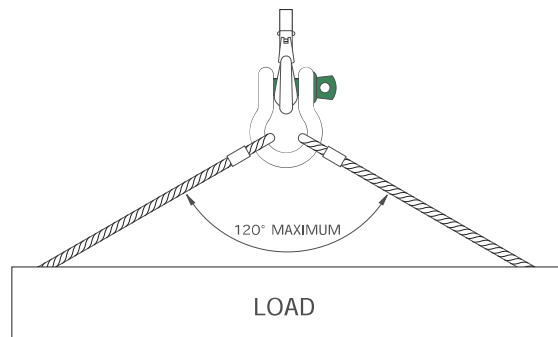

When a shackle is used to connect two slings to the hook of a lifting device, a bow type shackle must be used. The slings must be connected to the shackle body, and the shackle pin must be placed in the hook. The angle between the slings should not exceed 120°. If symmetrically loaded the shackle may be used to the full WLL.

To avoid eccentric loading of the shackle a loose spacer may be used on either end of the shackle pin. Do not reduce the width between the shackle jaws by welding washers or spacers to the inside of the shackle eyes or by narrowing the jaws, as this will affect the WLL of the shackle.

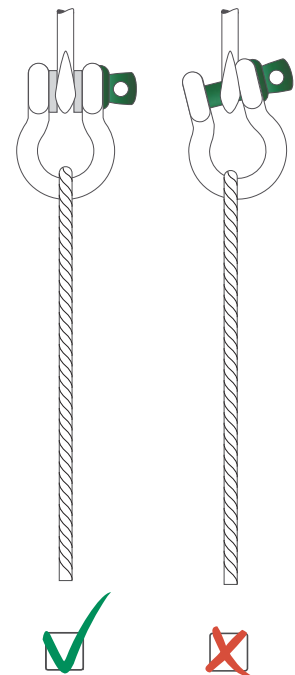

- 1
- 2
- 3
- 4
- 5
- 6
- 7
- 8
- 9
- 10
- 11
- 12
- 13
- 14
- 15
- 16
- 17
- 18
- 19
- 20

When a shackle is attached to the top block of a set of wire rope blocks the load on this shackle is increased by the value of the hoisting effect.

Avoid applications where the load moves over the shackle pin; the pin may rotate and possibly be unscrewed. If moving of the load cannot be avoided, or when the shackle is to be left in place for a prolonged period or where maximum pin security is required, use a shackle with a safety bolt, nut and cotter pin.

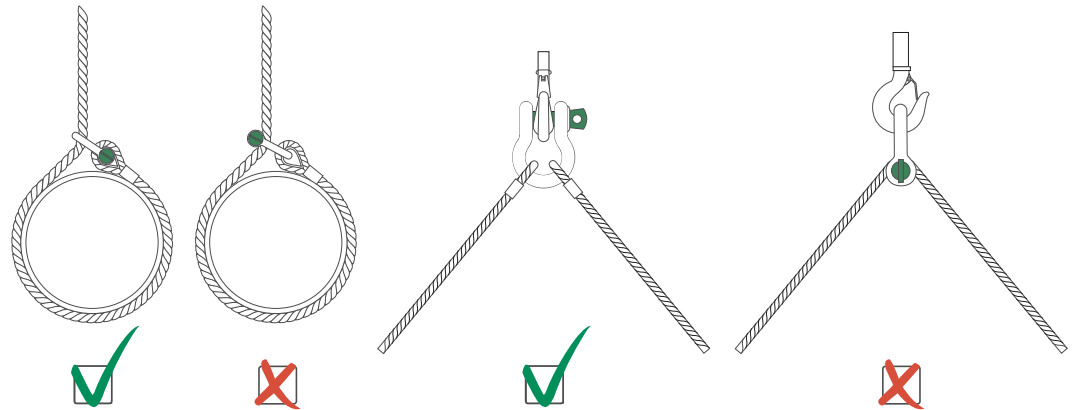

Shackles should not be immersed in acidic solutions or exposed to acidic fumes or other chemicals that are potentially harmful for the shackle.

Point loading

Shackles are used in lifting- and static systems as removable links to connect (steel) wire rope, chain and other fittings. Most of the times the load bearing component that connects to a shackle is of a rounded shape. Point loading of shackles during lifting operations is allowed but the minimum dimension of the rounded component to be lifted should be equal to or bigger than the bow size of the shackle being used. The maximum load of the configuration is limited by the component with the lowest WLL.

Increasing the contact area by using bigger diameters and/or pad eyes can be an advantage. Sharp edges should be avoided.

Green Pin® shackles can also be used in below configurations. The maximum load of the configuration is limited by the component with the lowest WLL.

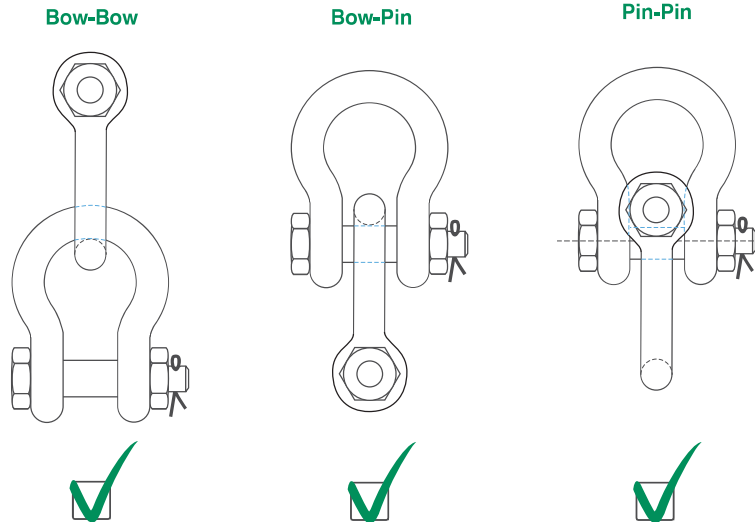

The crown of a Green Pin® Sling shackle is wider than that of a standard shackle, thus creating a bigger bearing surface. This improves the lifetime of the sling. Green Pin® Sling shackles can also be used in bellow configurations. The maximum load of the configuration is limited by the component with the lowest WLL.

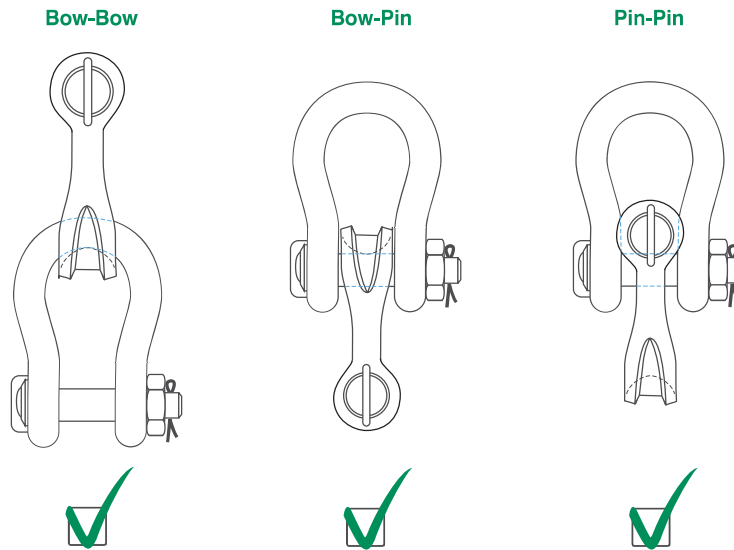

Pin- Pin configuration:

When the shackle eyes touch and the pins do not bear properly, the configuration should not be used.

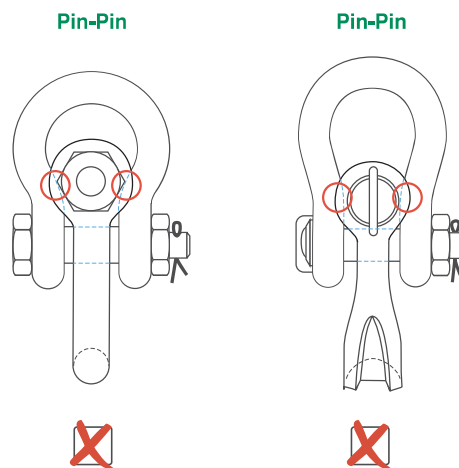

Bow- Pin configuration:

When the shackle body of the inner shackle touches the shackle eyes of the outer shackle and body and pin do not bear properly, the configuration should not be used.

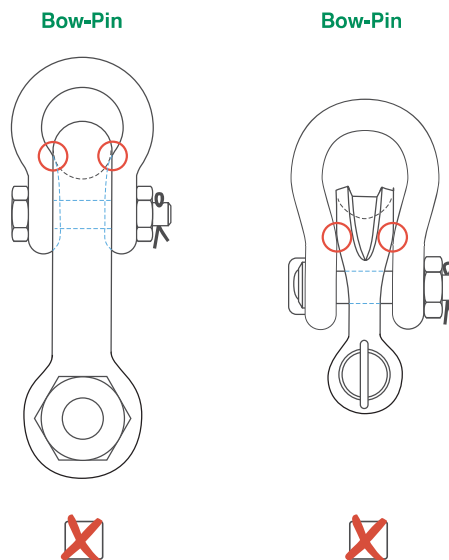

- 1
- 2
- 3
- 4
- 5
- 6
- 7
- 8
- 9
- 10
- 11
- 12
- 13
- 14
- 15
- 16
- 17
- 18
- 19
- 20

Temperature

If extreme temperature situations occur, the following load reductions must be taken into account:

Temperature	Reduction for elevated temperatures New Working Load Limit
up to 200°C	100% of original Working Load Limit
200 - 300°C	90% of original Working Load Limit
300 - 400°C	75% of original Working Load Limit
> 400°C	not allowed

The rating of shackles to EN 13889 assumes the absence of exceptionally hazardous conditions. Exceptionally hazardous conditions include offshore activities, the lifting of persons and the lifting of potentially dangerous loads such as molten metals, corrosive materials or fissile materials. In such cases a competent person should assess the degree of hazard and the WLL should be reduced accordingly.

Inspection

Shackles must be regularly inspected in accordance with the safety standards given in the country of use. This is required because the products in use may be affected by wear, misuse, overloading etc. which may lead to deformation and alteration of the material structure.

Inspection should take place at least every six months and more frequently when the shackles are used in severe operating conditions.



- 1
- 2
- 3
- 4
- 5
- 6
- 7
- 8
- 9
- 10
- 11
- 12
- 13
- 14
- 15
- 16
- 17
- 18
- 19
- 20



G-4161

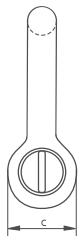
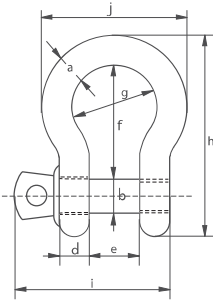

Green Pin® Standard Shackles

bow shackles with screw collar pin

- **Material** : bow and pin high tensile steel, Grade 6, quenched and tempered
- **Safety Factor** : MBL equals 6 x WLL
- **Standard** : EN 13889 and
meets performance requirements of US Fed. Spec. RR-C-271 Type IVA Class 2, Grade A from 2 t and upward these shackles comply with ASME B30.26
- **Finish** : hot dipped galvanized
- **Temperature Range** : -40°C up to +200°C
- **Certification** : **2.1** **2.2** **3.1** **MTC^a** **DNV 2.7-1^a *** **DNV 2.7-1^b *** **DNV 2.22** **CE**

working load limit	diameter bow	diameter pin	diameter eye	width eye	width inside	length inside	width bow	length	length bolt	width	weight each
t	a	b	c	d	e	f	g	h	i	j	kg
0.33	5	6	12	5	9.5	22	16	36	29.5	26	0.02
0.5	7	8	16.5	7	12	29	20	48.5	38	34	0.05
0.75	9	10	20	9	13.5	32	22	56	46.5	40	0.1
1	10	11	22.5	10	17	36.5	26	63.5	54	46	0.14
1.5	11	13	26.5	11	19	43	29	74	59.5	51	0.19
2	13.5	16	34	13	22	51	32	89	73	58	0.36
3.25	16	19	40	16	27	64	43	110	89	75	0.63
4.75	19	22	46	19	31	76	51	129	103	89	1.01
6.5	22	25	52	22	36	83	58	144	119	102	1.5
8.5	25	28	59	25	43	95	68	164	137	118	2.21
9.5	28	32	66	28	47	108	75	185	153	131	3.16
12	32	35	72	32	51	115	83	201	170	147	4.31
13.5	35	38	80	35	57	133	92	227	186	162	5.55
17	38	42	88	38	60	146	99	249	203	175	7.43
25	45	50	103	45	74	178	126	300	243	216	12.84
35	50	57	111	50	83	197	138	331	272	238	18.15
42.5	57	65	130	57	95	222	160	377	310	274	26.29
55	65	70	145	65	105	260	180	433	344	310	37.6

In inch

working load limit	diameter bow	diameter pin	diameter eye	width eye	width inside	length inside	width bow	length	length bolt	width	weight each
t	a	b	c	d	e	f	g	h	i	j	lbs
0.33	3/16	1/4	1/2	3/16	3/8	7/8	5/8	1 13/32	1 5/32	1 1/32	0.05
0.5	1/4	5/16	21/32	9/32	15/32	1 5/32	25/32	1 29/32	1 1/2	1 11/32	0.11
0.75	5/16	3/8	25/32	11/32	17/32	1 1/4	7/8	2 7/32	1 27/32	1 9/16	0.22
1	3/8	7/16	7/8	13/32	21/32	1 7/16	1 1/32	2 1/2	2 1/8	1 13/16	0.3
1.5	7/16	1/2	1 1/32	7/16	3/4	1 11/16	1 5/32	2 29/32	2 11/32	2	0.42
2	1/2	5/8	1 11/32	1/2	7/8	2	1 1/4	3 1/2	2 7/8	2 9/32	0.79
3.25	5/8	3/4	1 9/16	5/8	1 1/16	2 17/32	1 11/16	4 11/32	3 1/2	2 15/16	1.38
4.75	3/4	7/8	1 13/16	3/4	1 7/32	3	2	5 3/32	4 1/16	3 1/2	2.22
6.5	7/8	1	2 1/16	7/8	1 13/32	3 9/32	2 9/32	5 21/32	4 11/16	4 1/32	3.31
8.5	1	1 1/8	2 5/16	31/32	1 11/16	3 3/4	2 11/16	6 15/32	5 13/32	4 21/32	4.86
9.5	1 1/8	1 1/4	2 19/32	1 3/32	1 27/32	4 1/4	2 15/16	7 9/32	6 1/32	5 5/32	6.97
12	1 1/4	1 3/8	2 27/32	1 1/4	2	4 17/32	3 9/32	7 29/32	6 11/16	5 25/32	9.49
13.5	1 3/8	1 1/2	3 5/32	1 3/8	2 1/4	5 1/4	3 5/8	8 15/16	7 5/16	6 3/8	12.24
17	1 1/2	1 5/8	3 15/32	1 1/2	2 3/8	5 3/4	3 29/32	9 13/16	8	6 7/8	16.37
25	1 3/4	2	4 1/16	1 25/32	2 29/32	7	4 31/32	11 13/16	9 9/16	8 1/2	28.31
35	2	2 1/4	4 3/8	1 31/32	3 9/32	7 3/4	5 7/16	13 1/32	10 23/32	9 3/8	40.01
42.5	2 1/4	2 9/16	5 1/8	2 1/4	3 3/4	8 3/4	6 5/16	14 27/32	12 7/32	10 25/32	57.96
55	2 1/2	2 3/4	5 23/32	2 9/16	4 1/8	10 1/4	7 3/32	17 1/16	13 17/32	12 7/32	82.89



RFID CAD

* For shackles ≥ WLL 2 t



Green Pin® Standard Shackles

bow shackles with safety bolt

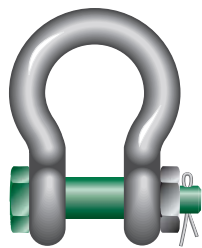

G-4163

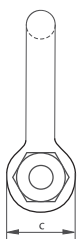
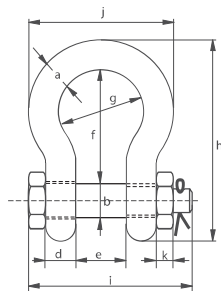

- **Material** : bow and pin high tensile steel, Grade 6, quenched and tempered
- **Safety Factor** : MBL equals 6 x WLL
- **Standard** : EN 13889 and meets performance requirements of US Fed. Spec. RR-C-271 Type IVA Class 3, Grade A from 2 t and upward these shackles comply with ASME B30.26
- **Finish** : hot dipped galvanized
- **Temperature Range** : -40°C up to +200°C
- **Certification** : **2.1** **2.2** **3.1** **MTC^a** **DNV 2.7-1^a *** **DNV 2.7-1^b *** **DNV 2.22** **CE**

working load limit	diameter bow	diameter pin	diameter eye	width eye	width inside	length inside	width bow	length bow	length bolt	width nut	thickness nut	weight each
t	a mm	b mm	c mm	d mm	e mm	f mm	g mm	h mm	i mm	j mm	k mm	kg
0.5	7	8	16.5	7	12	29	20	48.5	42	34	4	0.06
0.75	9	10	20	9	13.5	32	22	56	50	40	5	0.11
1	10	11	22.5	10	17	36.5	26	63.5	60	46	8	0.16
1.5	11	13	26.5	11	19	43	29	74	67	51	11	0.22
2	13.5	16	34	13	22	51	32	89	82	58	13	0.42
3.25	16	19	40	16	27	64	43	110	98	75	17	0.74
4.75	19	22	46	19	31	76	51	129	114	89	19	1.18
6.5	22	25	52	22	36	83	58	144	130	102	22	1.77
8.5	25	28	59	25	43	95	68	164	150	118	25	2.58
9.5	28	32	66	28	47	108	75	185	166	131	27	3.66
12	32	35	72	32	51	115	83	201	178	147	30	4.91
13.5	35	38	80	35	57	133	92	227	197	162	33	6.54
17	38	42	88	38	60	146	99	249	202	175	19	8.19
25	45	50	103	45	74	178	126	300	249	216	23	14.22
35	50	57	111	50	83	197	138	331	269	238	26	19.53
42.5	57	65	130	57	95	222	160	377	301	274	29	28.33
55	65	70	145	65	105	260	180	433	330	310	32	39.59
85	75	83	162	73	127	329	190	527	380	340	39	62

In inch

working load limit	diameter bow	diameter pin	diameter eye	width eye	width inside	length inside	width bow	length bow	length bolt	width nut	thickness nut	weight each
t	a inch	b inch	c inch	d inch	e inch	f inch	g inch	h inch	i inch	j inch	k inch	lbs
0.5	1/4	5/16	21/32	9/32	15/32	1 5/32	25/32	1 29/32	1 21/32	1 11/32	5/32	0.13
0.75	5/16	3/8	25/32	11/32	17/32	1 1/4	7/8	2 7/32	1 31/32	1 9/16	3/16	0.25
1	3/8	7/16	7/8	13/32	21/32	1 7/16	1 1/32	2 1/2	2 3/8	1 13/16	5/16	0.34
1.5	7/16	1/2	1 1/32	7/16	3/4	1 11/16	1 5/32	2 29/32	2 5/8	2	7/16	0.48
2	1/2	5/8	1 11/32	1/2	7/8	2	1 1/4	3 1/2	3 7/32	2 9/32	1/2	0.92
3.25	5/8	3/4	1 9/16	5/8	1 1/16	2 17/32	1 11/16	4 11/32	3 27/32	2 15/16	21/32	1.62
4.75	3/4	7/8	1 13/16	3/4	1 7/32	3	2	5 3/32	4 1/2	3 1/2	3/4	2.59
6.5	7/8	1	2 1/16	7/8	1 13/32	3 9/32	2 9/32	5 21/32	5 1/8	4 1/32	7/8	3.9
8.5	1	1 1/8	2 5/16	31/32	1 11/16	3 3/4	2 11/16	6 15/32	5 29/32	4 21/32	31/32	5.69
9.5	1 1/8	1 1/4	2 19/32	1 3/32	1 27/32	4 1/4	2 15/16	7 9/32	6 17/32	5 5/32	1 1/16	8.06
12	1 1/4	1 3/8	2 27/32	1 1/4	2	4 17/32	3 9/32	7 29/32	7	5 25/32	1 3/16	10.81
13.5	1 3/8	1 1/2	3 5/32	1 3/8	2 1/4	5 1/4	3 5/8	8 15/16	7 3/4	6 3/8	1 5/16	14.42
17	1 1/2	1 5/8	3 15/32	1 1/2	2 3/8	5 3/4	3 29/32	9 13/16	7 15/16	6 7/8	3/4	18.06
25	1 3/4	2	4 1/16	1 25/32	2 29/32	7	4 31/32	11 13/16	9 13/16	8 1/2	29/32	31.34
35	2	2 1/4	4 3/8	1 31/32	3 9/32	7 3/4	5 7/16	13 1/32	10 19/32	9 3/8	1 1/32	43.77
42.5	2 1/4	2 9/16	5 1/8	2 1/4	3 3/4	8 3/4	6 5/16	14 27/32	11 27/32	10 23/32	1 5/32	62.46
55	2 1/2	2 3/4	5 29/32	2 9/16	4 1/8	10 1/4	7 3/32	17 1/16	13	12 7/32	1 1/4	87.27
85	3	3 1/4	6 3/8	2 7/8	5	12 15/16	7 15/32	20 3/4	14 31/32	13 3/8	1 17/32	136.69



* For shackles ≥ WLL 2 t

RFID CAD

1
2
3
4
5
6
7
8
9
10
11
12
13
14
15
16
17
18
19
20



G-4151

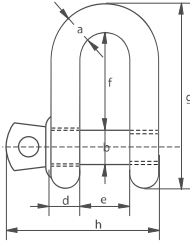

Green Pin® Standard Shackles

dee shackles with screw collar pin

- **Material** : bow and pin high tensile steel, Grade 6, quenched and tempered
- **Safety Factor** : MBL equals 6 x WLL
- **Standard** : EN 13889, ASME B30.26 and meets performance requirements of US Fed. Spec. RR-C-271 Type IVB Class 3, Grade A
- **Finish** : hot dipped galvanized
- **Temperature Range** : -40°C up to +200°C
- **Certification** : 2.1 2.2 3.1 MTC^a DNV 2.7-1^a * DNV 2.7-1^b * DNV 2.22 CE

working load limit	diameter bow	diameter pin	diameter eye	width eye	width inside	length inside	length	length bolt	weight each
t	a mm	b mm	c mm	d mm	e mm	f mm	g mm	h mm	kg
0.33	5	6	12	5	9,5	19	33	29,5	0.02
0.5	7	8	16,5	7	12	22	41,5	38	0.05
0.75	9	10	20	9	13,5	26	50	46,5	0.09
1	10	11	22,5	10	17	32	59	54	0.14
1.5	11	13	26,5	11	19	37	68	59,5	0.19
2	13,5	16	34	13	22	43	81	73	0.32
3.25	16	19	40	16	27	51	97	89	0.54
4.75	19	22	46	19	31	59	112	103	0.87
6.5	22	25	52	22	36	73	134	119	1.34
8.5	25	28	59	25	43	85	154	137	2.08
9.5	28	32	66	28	47	90	167	153	2.77
12	32	35	72	32	51	94	180	170	3.72
13.5	35	38	80	35	57	115	209	186	5.14
17	38	42	88	38	60	127	230	203	6.85
25	45	50	103	45	74	149	271	243	11.45
35	50	57	111	50	83	171	305	272	16.86
42.5	57	65	130	57	95	190	345	310	24.61
55	65	70	145	65	105	203	376	344	32.65

In inch

working load limit	diameter bow	diameter pin	diameter eye	width eye	width inside	length inside	length	length bolt	weight each
t	a inch	b inch	c inch	d inch	e inch	f inch	g inch	h inch	lbs
0.33	3/16	1/4	15/32	3/16	3/8	3/4	1 5/16	1 5/32	0.04
0.5	1/4	5/16	21/32	9/32	15/32	7/8	1 5/8	1 1/2	0.11
0.75	5/16	3/8	25/32	11/32	17/32	1 1/32	1 31/32	1 27/32	0.2
1	3/8	7/16	7/8	13/32	21/32	1 1/4	2 5/16	2 1/8	0.3
1.5	7/16	1/2	1 1/32	7/16	3/4	1 15/32	2 11/16	2 11/32	0.42
2	1/2	5/8	1 11/32	1/2	7/8	1 11/16	3 3/16	2 7/8	0.7
3.25	5/8	3/4	1 9/16	5/8	1 1/16	2	3 13/16	3 1/2	1.19
4.75	3/4	7/8	1 13/16	3/4	1 7/32	2 5/16	4 12/32	4 1/16	1.92
6.5	7/8	1	2 1/16	7/8	1 13/32	2 7/8	5 9/32	4 11/16	2.95
8.5	1	1 1/8	2 5/16	31/32	1 11/16	3 11/32	6 1/16	5 13/32	4.59
9.5	1 1/8	1 1/4	2 19/32	1 3/32	1 27/32	3 17/32	6 9/16	6 1/32	6.1
12	1 1/4	1 3/8	2 27/32	1 1/4	2	3 11/16	7 3/32	6 11/16	8.2
13.5	1 3/8	1 1/2	3 5/32	1 3/8	2 1/4	4 17/32	8 7/32	7 5/16	11.33
17	1 1/2	1 5/8	3 15/32	1 1/2	2 3/8	5	9 1/16	8	15.1
25	1 3/4	2	4 1/16	1 25/32	2 29/32	5 7/8	10 21/32	9 9/16	25.23
35	2	2 1/4	4 3/8	1 31/32	3 9/32	6 23/32	12	10 23/32	37.17
42.5	2 1/4	2 9/16	5 1/8	2 1/4	3 3/4	7 15/32	13 19/32	12 7/32	54.26
55	2 1/2	2 3/4	5 23/32	2 9/16	4 1/8	8	14 13/16	13 17/32	71.98

RFID CAD



* For shackles ≥ WLL 2 t



Green Pin® Standard Shackles

dee shackles with safety bolt



G-4153

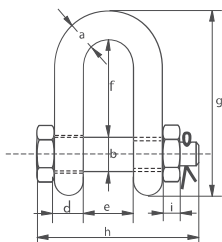

- **Material** : bow and pin high tensile steel, Grade 6, quenched and tempered
- **Safety Factor** : MBL equals 6 x WLL
- **Standard** : EN 13889, ASME B30.26 and meets performance requirements of US Fed. Spec. RR-C-271 Type IVB Class 3, Grade A
- **Temperature Range** : -40°C up to +200°C
- **Certification** : 2.1 2.2 3.1 MTC^a DNV 2.7-1^a* DNV 2.7-1^b* DNV 2.22 CE

working load limit	diameter bow	diameter pin	diameter eye	width eye	width inside	length inside	length	length bolt	thickness nut	weight each
t	a mm	b mm	c mm	d mm	e mm	f mm	g mm	h mm	i mm	kg
2	13,5	16	34	13	22	43	81	82	13	0,39
3.25	16	19	40	16	27	51	97	98	17	0,67
4.75	19	22	46	19	31	59	112	114	19	1,08
6.5	22	25	52	22	36	73	134	130	22	1,66
8.5	25	28	59	25	43	85	154	150	25	2,46
9.5	28	32	66	28	47	90	167	166	27	3,4
12	32	35	72	32	51	94	180	178	30	4,51
13.5	35	38	80	35	57	115	209	197	33	6,1
17	38	42	88	38	60	127	230	202	19	7,63
25	45	50	103	45	74	149	271	249	23	12,88
35	50	57	111	50	83	171	305	269	26	17,35
42.5	57	65	130	57	95	190	345	301	29	25,94
55	65	70	145	65	105	203	376	330	32	35,33
85	75	83	162	73	127	229	427	380	39	52,97

In inch

working load limit	diameter bow	diameter pin	diameter eye	width eye	width inside	length inside	length	length bolt	thickness nut	weight each
t	a inch	b inch	c inch	d inch	e inch	f inch	g inch	h inch	i inch	lbs
2	1/2	5/8	1 11/32	1/2	7/8	1 11/16	3 3/16	3 7/32	1/2	0.85
3.25	5/8	3/4	1 9/16	5/8	1 1/16	2	3 13/16	3 27/32	21/32	1.48
4.75	3/4	7/8	1 13/16	3/4	1 7/32	2 5/16	4 13/32	4 1/2	3/4	2.39
6.5	7/8	1	2 1/16	7/8	1 13/32	2 7/8	5 9/32	5 1/8	7/8	3.66
8.5	1	1 1/8	2 5/16	31/32	1 11/16	3 11/32	6 1/16	5 29/32	31/32	5.42
9.5	1 1/8	1 1/4	2 19/32	1 3/32	1 27/32	3 17/32	6 9/16	6 17/32	1 1/16	7.5
12	1 1/4	1 3/8	2 27/32	1 1/4	2	3 11/16	7 3/32	7	1 3/16	9.95
13.5	1 3/8	1 1/2	3 5/32	1 3/8	2 1/4	4 17/32	8 7/32	7 3/4	1 5/16	13.45
17	1 1/2	1 5/8	3 15/32	1 1/2	2 3/8	5	9 1/16	7 15/16	3/4	16.82
25	1 3/4	2	4 1/16	1 25/32	2 29/32	5 7/8	10 21/32	9 13/16	29/32	28.4
35	2	2 1/4	4 3/8	1 31/32	3 9/32	6 23/32	12	10 19/32	1 1/32	38.25
42.5	2 1/4	2 9/16	5 1/8	2 1/4	3 3/4	7 15/32	13 19/32	11 27/32	1 5/32	57.19
55	2 1/2	2 3/4	5 23/32	2 9/16	4 1/8	8	14 13/16	13	1 1/4	77.89
85	3	3 1/4	6 3/8	2 7/8	5	9 1/32	16 13/16	14 31/32	1 17/32	116.77

RFID CAD



* For shackles ≥ WLL 2 t

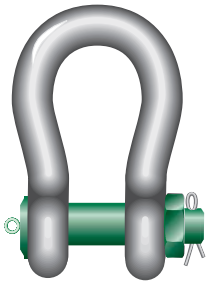

P-6036

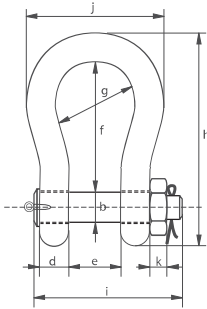

Green Pin® Heavy Duty Shackles

bow shackles with safety bolt

- **Material** : bow and pin alloy steel, Grade 8 quenched and tempered
- **Safety Factor** : MBL equals 5 x WLL
- **Finish** : shackle bow painted silver, pin painted green (120 tons shackle is hot dipped galvanized)
- **Certification** : 2.1 2.2 3.1 MTC^a MTC^b * LROS * MPI^a US^a CE

working load limit	diameter bow	diameter pin	diameter eye	width eye	width inside	length inside	width bow	length bow	length bolt	width bolt	thickness nut	weight each
t	a	b	c	d	e	f	g	h	i	j	k	kg
120	95	95	208	91	147	400	238	647	440	428	50	110
150	105	108	238	102	169	410	275	688	490	485	60	160
200	120	130	279	113	179	513	290	838	520	530	60	235
250	130	140	299	118	205	554	305	904	560	565	65	285
300	140	150	325	123	205	618	305	996	575	585	70	340
400	170	175	376	164	231	668	325	1114	690	665	70	560
500	180	185	398	164	256	718	350	1190	720	710	70	685
600	200	205	444	189	282	718	375	1243	810	775	70	880
700	210	215	454	204	308	718	400	1263	870	820	70	980
800	210	220	464	204	308	718	400	1270	870	820	70	1100
900	220	230	485	215	328	718	420	1296	920	860	70	1280
1000	240	240	515	215	349	718	420	1336	940	900	70	1460
1250	260	270	585	230	369	768	450	1456	1025	970	70	1990
1500	280	290	625	230	369	818	450	1556	1025	1010	70	2400

In inch

working load limit	diameter bow	diameter pin	diameter eye	width eye	width inside	length inside	width bow	length bow	length bolt	width bolt	thickness nut	weight each
t	a	b	c	d	e	f	g	h	i	j	k	lbs
120	3 3/4	3 3/4	8 3/16	3 19/32	5 25/32	15 3/4	9 3/8	25 15/32	17 5/16	16 27/32	1 31/32	243
150	4 1/8	4 1/4	9 3/8	4 1/32	6 21/32	16 5/32	10 13/16	27 3/32	19 9/32	19 3/32	2 3/8	353
200	4 23/32	5 1/8	10 31/32	4 7/16	7 1/16	20 3/16	11 13/32	33	20 15/32	20 7/8	2 3/8	518
250	5 1/8	5 1/2	11 25/32	4 21/32	8 1/16	21 13/16	12	35 19/32	22 1/16	22 1/4	2 9/16	628
300	5 1/2	5 29/32	12 25/32	4 27/32	8 1/16	24 11/32	12	39 7/32	22 5/8	23 1/2	2 3/4	750
400	6 11/16	6 7/8	14 13/16	6 15/32	9 3/32	26 5/16	12 25/32	43 27/32	27 5/32	26 3/16	2 3/4	1235
500	7 3/32	7 9/32	15 21/32	6 15/32	10 9/32	28 9/32	13 25/32	46 27/32	28 11/32	27 15/16	2 3/4	1510
600	7 7/8	8 1/16	17 15/32	7 7/16	11 3/32	28 9/32	14 3/4	48 15/16	31 7/8	30 1/2	2 3/4	1940
700	8 9/32	8 15/32	17 7/8	8 1/32	12 1/8	28 9/32	15 3/4	49 23/32	34 1/4	32 9/32	2 3/4	2161
800	8 9/32	8 21/32	18 9/32	8 1/32	12 1/8	28 9/32	15 3/4	50	34 1/4	32 9/32	2 3/4	2425
900	8 21/32	9 1/16	19 3/32	8 15/32	12 29/32	28 9/32	16 17/32	51 1/32	36 7/32	33 27/32	2 3/4	2822
1000	9 7/16	9 7/16	20 9/32	8 15/32	13 3/4	28 9/32	16 17/32	52 19/32	37	35 7/16	2 3/4	3219
1250	10 1/4	10 5/8	23 1/32	9 1/16	14 17/32	30 1/4	17 23/32	57 5/16	40 11/32	38 3/16	2 3/4	4387
1500	11 1/32	11 13/32	24 19/32	9 1/16	14 17/32	32 7/32	17 23/32	61 1/4	40 11/32	39 3/4	2 3/4	5291

RFID CAD

* For shackles ≥ WLL 150 t



Green Pin® Heavy Duty Shackles

dee shackles with safety bolt

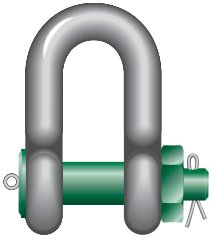

G-6038

- **Material** : bow and pin alloy steel, Grade 8, quenched and tempered
- **Safety Factor** : MBL equals 5 x WLL
- **Finish** : hot dipped galvanized
- **Certification** : 2.1 2.2 3.1 MTC^a MPI^a US^a CE

working load limit	diameter bow	diameter pin	diameter eye	width eye	width inside	length inside	length	length bolt	thickness nut	weight each
t	a	b	c	d	e	f	g	h	i	kg
120	95	95	208	95	147	274	521	440	50	110

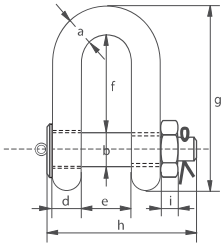

In inch

working load limit	diameter bow	diameter pin	diameter eye	width eye	width inside	length inside	length	length bolt	thickness nut	weight each
t	a	b	c	d	e	f	g	h	i	lbs
120	3 ³ / ₄	3 ³ / ₄	8 ³ / ₁₆	3 ³ / ₄	5 ²⁵ / ₃₂	10 ²⁵ / ₃₂	20 ¹ / ₂	17 ⁵ / ₁₆	1 ³¹ / ₃₂	243

RFID CAD

- 1
- 2
- 3
- 4
- 5
- 6
- 7
- 8
- 9
- 10
- 11
- 12
- 13
- 14
- 15
- 16
- 17
- 18
- 19
- 20

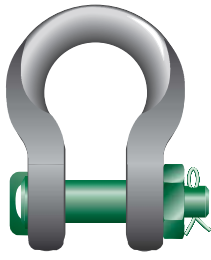

P-6033

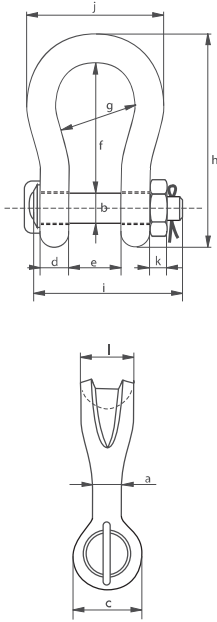

Green Pin® Sling Shackles

bow shackles with safety bolt

- **Material** : bow and pin alloy steel, Grade 8, quenched and tempered
- **Safety Factor** : MBL equals 5 x WLL
- **Finish** : shackle bow painted silver, pin painted green
- **Temperature Range** : -20 °C up to +200 °C
- **Certification** : 2.1 2.2 3.1 MTC^b * LROS * MPI^b * US^b * CE

working load limit	diameter body	diameter pin	diameter eye	width eye	width inside	length inside	width bow	length	length bolt	width	thickness nut	bearing surface	weight each
t	a	b	c	d	e	f	g	h	i	j	k	l	kg
	mm	mm	mm	mm	mm	mm	mm	mm	mm	mm	mm	mm	
7	22	22	46	19	32	96	64	153	115	110	19	41	2
12.5	28	28	61	25	44	121	82	197	151	146	24	54	4
18	35	35	69	30	54	148	102	239	175	180	29	64	7
30	40	42	90	35	69	165	126	279	211	200	34	79	13
40	55	51	109	45	84	199	140	331	252	235	38	97	21
55	60	57	115	55	90	240	160	389	299	270	45	100	30
75	68	70	125	54	110	290	185	473	327	317	54	120	48
125	85	80	154	85	137	366	220	583	426	390	64	150	92
150	94	95	179	89	147	391	253	645	435	434	50	170	140
200	110	105	199	100	158	481	280	759	470	482	50	205	205
250	126	120	227	110	179	542	300	859	519	530	60	240	264
300	135	134	245	122	195	601	350	947	575	620	70	265	360
400	160	160	293	145	231	576	370	985	675	690	80	320	580
500	170	180	328	160	263	681	450	1131	748	790	90	339	780
600	190	200	348	170	289	741	490	1234	809	865	100	370	980
700	200	215	392	190	315	751	540	1284	879	901	100	400	1360
800	218	230	420	200	342	851	554	1426	942	947	110	420	1430
900	242	255	466	220	368	851	580	1488	1023	1023	120	440	1650
1000	260	270	490	240	399	851	614	1532	1103	1107	120	460	2970
1250	285	300	510	260	452	931	650	1666	1227	1182	150	530	3700
1550	285	320	550	280	483	950	680	1710	1300	1253	150	560	4000

In inch

working load limit	diameter body	diameter pin	diameter eye	width eye	width inside	length inside	width bow	length	length bolt	width	thickness nut	bearing surface	weight each
t	a	b	c	d	e	f	g	h	i	j	k	l	lbs
	inch	inch	inch	inch	inch	inch	inch	inch	inch	inch	inch	inch	
7	7/8	7/8	1 13/16	3/4	1 9/32	3 25/32	2 17/32	6	4 17/32	4 5/16	3/4	1 5/18	4.41
12.5	1 1/8	1 1/8	2 3/8	1	1 3/4	4 3/4	3 1/4	7 3/4	5 15/16	5 3/4	15/16	2 1/8	8.82
18	1 3/8	1 3/8	2 23/32	1 3/16	2 1/8	5 13/16	4 1/32	9 13/32	6 7/8	7 3/32	1 5/32	2 17/32	18
30	1 9/16	1 21/32	3 17/32	1 3/8	2 23/32	6 1/2	4 31/32	10 31/32	8 5/16	7 7/8	1 11/32	3 1/8	29
40	2 5/32	2	4 9/32	1 25/32	3 5/16	7 27/32	5 1/2	13 1/32	9 29/32	9 1/4	1 1/2	3 13/16	46
55	2 3/8	2 1/4	4 17/32	2 5/32	3 17/32	9 7/16	6 5/16	15 5/16	11 25/32	10 5/8	1 25/32	3 15/16	66
75	2 11/16	2 3/4	4 29/32	2 1/8	4 11/32	11 13/32	7 9/32	18 5/8	12 7/8	12 15/32	2 1/8	4 23/32	106
125	3 11/32	3 5/32	6 1/16	3 11/32	5 13/32	14 13/32	8 21/32	22 15/16	16 25/32	15 11/32	2 17/32	5 29/32	203
150	3 11/16	3 3/4	7 1/16	3 1/2	5 25/32	15 13/32	9 31/32	25 13/32	17 1/8	17 3/32	1 31/32	6 11/16	309
200	4 11/32	4 1/8	7 27/32	3 15/16	6 7/32	18 15/16	11 1/32	29 7/8	18 1/2	18 31/32	1 31/32	8 1/16	452
250	4 31/32	4 23/32	8 15/16	4 11/32	7 1/16	21 11/32	11 13/16	33 13/16	20 7/16	20 7/8	2 3/8	9 7/16	582
300	5 5/16	5 9/32	9 21/32	4 13/16	7 11/16	23 21/32	13 25/32	37 9/32	22 5/8	24 13/32	2 3/4	10 7/16	794
400	6 5/16	6 5/16	11 17/32	5 23/32	9 3/32	22 11/16	14 9/16	38 25/32	26 9/16	27 5/32	3 5/32	12 19/32	1279
500	6 11/16	7 3/32	12 29/32	6 5/16	10 11/32	26 13/16	17 23/32	44 17/32	29 7/16	31 3/32	3 17/32	13 11/32	1720
600	7 15/32	7 7/8	13 11/16	6 11/16	11 3/8	29 3/16	19 9/32	48 19/32	31 27/32	34 1/16	3 15/16	14 9/16	2161
700	7 1/8	8 15/32	15 7/16	7 5/32	12 13/32	29 9/16	21 1/4	50 9/16	34 19/32	35 15/32	3 15/16	15 3/4	2998
800	8 19/32	9 1/16	16 17/32	7 7/8	13 15/32	33 1/2	21 13/16	56 5/32	37 3/32	37 9/32	4 11/32	16 17/32	3153
900	9 17/32	10 1/32	18 11/32	8 21/32	14 1/2	33 1/2	22 27/32	58 19/32	40 9/32	40 9/32	4 23/32	17 5/16	3638
1000	10 1/4	10 5/8	19 9/32	9 7/16	15 23/32	33 1/2	24 3/16	60 5/16	43 7/16	43 19/32	4 23/32	18 1/8	6548
1250	11 7/32	11 13/16	20 3/32	10 1/4	17 25/32	36 21/32	25 19/32	65 19/32	48 5/16	46 17/32	5 29/32	20 7/8	8157
1550	11 7/32	12 19/32	21 21/32	11 1/32	19 1/32	37 13/32	26 25/32	67 5/16	51 3/16	49 11/32	5 29/32	22 1/16	8818



* For shackles ≥ WLL 75 t

Green Pin® Super Shackles

bow shackles with safety bolt

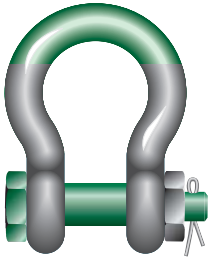

G-5263

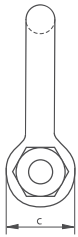
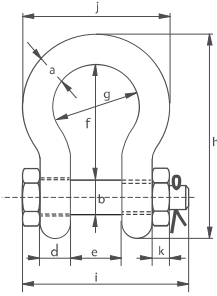

- **Material** : bow and pin alloy steel, Grade 8, quenched and tempered
- **Safety Factor** : MBL equals 5 x WLL
- **Standard** : ASME B30.26 and meets performance requirements of US Fed. Spec. RR-C-271 Type IVA Class 3, Grade B
- **Finish** : hot dipped galvanized (175 ton shackle is painted)
- **Temperature Range** : -20 °C up to +200 °C
- **Certification** : 2.1 2.2 3.1 MTC^a CE

working load limit	diameter bow	diameter pin	diameter eye	width eye	width inside	length inside	width bow	length	length bolt	width	thickness nut	weight each
t	a	b	c	d	e	f	g	h	i	j	k	kg
3.3	13.5	16	34	13	22	51	32	89	82	58	13	0.40
5	16	19	40	16	27	64	43	110	98	75	17	0.73
7	19	22	46	19	31	76	51	129	114	89	19	1.19
9.5	22	25	52	22	36	83	58	144	130	102	22	1.73
12.5	25	28	59	25	43	95	68	164	150	118	25	2.56
15	28	32	66	28	47	108	75	185	166	131	27	3.6
18	32	35	72	32	51	115	83	201	178	147	30	4.95
21	35	38	80	35	57	133	92	227	197	162	33	6.62
30	38	42	88	38	60	146	99	249	217	175	34	8.11
40	45	50	103	45	74	178	126	300	260	216	40	15
55	57	57	117	57	83	197	138	341	303	252	46	23
85	70	70	143	70	105	260	180	437	363	320	56	44
120	83	83	162	83	127	329	190	535	425	356	66	72
150*	95	95	208	91	147	400	238	647	511	428	50	112
175*	105	108	238	102	169	410	275	688	561	485	60	160

* = round headed bolt

In inch

working load limit	diameter bow	diameter pin	diameter eye	width eye	width inside	length inside	width bow	length	length bolt	width	thickness nut	weight each
t	a	b	c	d	e	f	g	h	i	j	k	lbs
3.3	1/2	5/8	1 11/32	1/2	7/8	2	1 1/4	3 1/2	3 7/32	2 9/32	1/2	0.88
5	5/8	3/4	1 9/16	5/8	1 1/16	2 17/32	1 11/16	4 11/32	3 27/32	2 15/16	21/32	1.61
7	3/4	7/8	1 13/16	3/4	1 7/32	3	2	5 3/32	4 1/2	3 1/2	3/4	2.62
9.5	7/8	1	2 1/16	7/8	1 13/32	3 9/32	2 9/32	5 21/32	5 1/8	4 1/32	7/8	3.81
12.5	1	1 1/8	2 5/16	31/32	1 11/16	3 3/4	2 11/16	6 15/32	5 29/32	4 21/32	31/32	5.64
15	1 1/8	1 1/4	2 19/32	1 3/32	1 27/32	4 1/4	2 15/16	7 9/32	6 17/32	5 5/32	1 1/16	7.94
18	1 1/4	1 3/8	2 27/32	1 1/4	2	4 17/32	3 9/32	7 29/32	7	5 25/32	1 3/16	10.91
21	1 3/8	1 1/2	3 5/32	1 3/8	2 1/4	5 1/4	3 5/8	8 15/16	7 3/4	6 3/8	1 5/16	14.59
30	1 1/2	1 5/8	3 15/32	1 1/2	2 3/8	5 3/4	3 29/32	9 13/16	8 17/32	6 7/8	1 5/16	17.88
40	1 3/4	2	4 1/16	1 25/32	2 29/32	7	4 31/32	11 13/16	10 1/4	8 1/2	1 9/16	33.07
55	2	2 1/4	4 19/32	2 1/4	3 9/32	7 3/4	5 7/16	13 7/16	11 15/16	9 29/32	1 25/32	50.71
85	2 1/2	2 3/4	5 5/8	2 3/4	4 1/8	10 1/4	7 3/32	17 7/32	14 9/32	12 19/32	2 7/32	97
120	3	3 1/4	6 3/8	3 9/32	5	12 15/16	7 15/32	21 1/16	16 23/32	14 1/32	2 5/8	158.73
150*	3 3/4	3 3/4	8 3/16	3 19/32	5 25/32	15 3/4	9 3/8	25 15/32	20 1/8	16 27/32	1 31/32	246.92
175*	4	4 1/4	9 3/8	4 1/32	6 21/32	16 5/32	10 13/16	27 3/32	22 3/32	19 3/32	2 3/8	352.74

* = round headed bolt

RFID CAD

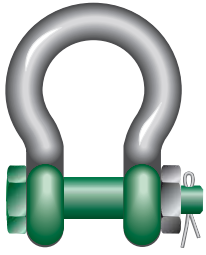

G-5163

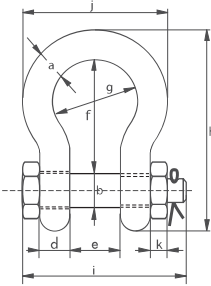

Green Pin® Polar Shackles

bow shackles with safety bolt, for use under extreme climatic conditions

- **Material** : bow and pin alloy steel, Grade 8, quenched and tempered
- **Safety Factor** : MBL equals 8 x WLL
for shackles with WLL 55 and 85 tons the MBL equals 6 x WLL
- **Standard** : EN 13889, ASME B30.26 and
meets performance requirements of US Fed. Spec. RR-C-271 Type IVA Class 3, Grade A
- **Finish** : hot dipped galvanized
- **Temperature Range** : -60°C up to +200°C
- **Certification** : [2.1](#) [2.2](#) [3.1](#) [MTC^a](#) [DNV 2.7-1^a](#) [DNV 2.7-1^b](#) [DNV 2.22](#) [CE](#)

working load limit	diameter bow	diameter pin	diameter eye	width eye	width inside	length inside	width bow	length	length bolt	width	thickness nut	weight each
t	a	b	c	d	e	f	g	h	i	j	k	kg
2	13,5	16	34	13	22	51	32	89	82	58	13	0.42
3.25	16	19	40	16	27	64	43	110	98	75	17	0.74
4.75	19	22	46	19	31	76	51	129	114	89	19	1.18
6.5	22	25	52	22	36	83	58	144	130	102	22	1.77
8.5	25	28	59	25	43	95	68	164	150	118	25	2.58
9.5	28	32	66	28	47	108	75	185	166	131	27	3.66
12	32	35	72	32	51	115	83	201	178	147	30	4.91
13.5	35	38	80	35	57	133	92	227	197	162	33	6.54
17	38	42	88	38	60	146	99	249	202	175	19	8.19
25	45	50	103	45	74	178	126	300	249	216	23	14.22
35	50	57	116	50	83	197	138	334	269	238	26	19.85
42.5	57	65	130	57	95	222	160	377	301	274	29	28.33
55	65	70	145	65	105	260	180	433	330	310	32	39.59
85	75	83	162	73	127	329	190	527	380	340	39	62

In inch

working load limit	diameter bow	diameter pin	diameter eye	width eye	width inside	length inside	width bow	length	length bolt	width	thickness nut	weight each
t	a	b	c	d	e	f	g	h	i	j	k	lbs
2	1/2	5/8	1 11/32	1/2	7/8	2	1 1/4	3 1/2	3 7/32	2 9/32	1/2	0.92
3.25	5/8	3/4	1 9/16	5/8	1 1/16	2 17/32	1 11/16	4 11/32	3 27/32	2 15/16	21/32	1.62
4.75	3/4	7/8	1 13/16	3/4	1 7/32	3	2	5 3/32	4 1/2	3 1/2	3/4	2.59
6.5	7/8	1	2 1/16	7/8	1 13/32	3 9/32	2 9/32	5 21/32	5 1/8	4 1/32	7/8	3.9
8.5	1	1 1/8	2 5/16	31/32	1 11/16	3 3/4	2 11/16	6 15/32	5 29/32	4 21/32	31/32	5.69
9.5	1 1/8	1 1/4	2 19/32	1 3/32	1 27/32	4 1/4	2 15/16	7 9/32	6 17/32	5 5/32	1 1/16	8.06
12	1 1/4	1 3/8	2 27/32	1 1/4	2	4 17/32	3 9/32	7 29/32	7	5 25/32	1 3/16	10.81
13.5	1 3/8	1 1/2	3 5/32	1 3/8	2 1/4	5 1/4	3 5/8	8 15/16	7 3/4	6 3/8	1 5/16	14.42
17	1 1/2	1 5/8	3 15/32	1 1/2	2 3/8	5 3/4	3 29/32	9 13/16	7 15/16	6 7/8	3/4	18.06
25	1 3/4	2	4 1/16	1 25/32	2 29/32	7	4 31/32	11 13/16	9 13/16	8 1/2	29/32	31.34
35	2	2 1/4	4 9/16	1 31/32	3 9/32	7 3/4	5 7/16	13 5/32	10 19/32	9 3/8	1 1/32	43.77
42.5	2 1/4	2 9/16	5 1/8	2 1/4	3 3/4	8 3/4	6 5/16	14 27/32	11 27/32	10 25/32	1 5/32	62.46
55	2 1/2	2 3/4	5 23/32	2 9/16	4 1/8	10 1/4	7 3/32	17 1/16	13	12 7/32	1 1/4	87.27
85	3	3 1/4	6 3/8	2 7/8	5	12 15/16	7 15/32	20 3/4	14 31/32	13 3/8	1 17/32	136.69

RFID CAD



Green Pin® Heavy Duty Polar Shackles

bow shackles with safety bolt, for use under extreme climatic conditions

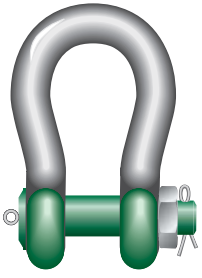

P-6031

- **Material** : bow and pin alloy steel, Grade 8, quenched and tempered
- **Safety Factor** : MBL equals 5 x WLL
- **Finish** : shackle bow painted silver, pin painted green (120 tons shackle is hot dipped galvanized)
- **Temperature Range** : -40 °C up to +200 °C
- **Certification** : 2.1 2.2 3.1 MTC^a MTC^b*

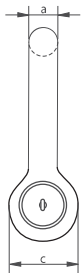
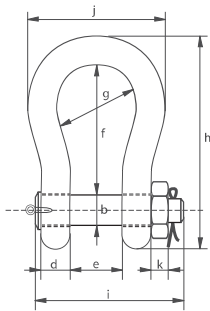

working load limit	diameter bow	diameter pin	diameter eye	width eye	width inside	length inside	width bow	length	length bolt	width	thickness nut	weight each
t	a	b	c	d	e	f	g	h	i	j	k	kg
120	95	95	208	91	147	400	238	647	440	428	50	110
150	105	108	238	102	169	410	275	688	490	485	60	160
200	120	130	279	113	179	513	290	838	520	530	60	235
250	130	140	299	118	205	554	305	904	560	565	65	285
300	140	150	325	123	205	618	305	996	575	585	70	340
400	170	175	376	164	231	668	325	1114	690	665	70	560
500	180	185	398	164	256	718	350	1190	720	710	70	685
600	200	205	444	189	282	718	375	1243	810	775	70	880
700	210	215	454	204	308	718	400	1263	870	820	70	980
800	210	220	464	204	308	718	400	1270	870	820	70	1100
900	220	230	485	215	328	718	420	1296	920	860	70	1280
1000	240	240	515	215	349	718	420	1336	940	900	70	1460
1250	260	270	585	230	369	768	450	1456	1025	970	70	1990
1500	280	290	625	230	369	818	450	1556	1025	1010	70	2400

In inch

working load limit	diameter bow	diameter pin	diameter eye	width eye	width inside	length inside	width bow	length	length bolt	width	thickness nut	weight each
t	a	b	c	d	e	f	g	h	i	j	k	lbs
120	3 3/4	3 3/4	8 3/16	3 19/32	5 25/32	15 3/4	9 3/8	25 15/32	17 5/16	16 27/32	1 31/32	243
150	4 1/8	4 1/4	9 3/8	4 1/32	6 21/32	16 5/32	10 13/16	27 3/32	19 9/32	19 3/32	2 3/8	353
200	4 23/32	5 1/8	10 31/32	4 7/16	7 1/16	20 3/16	11 13/32	33	20 15/32	20 7/8	2 3/8	518
250	5 1/8	5 1/2	11 25/32	4 21/32	8 1/16	21 13/16	12	35 19/32	22 1/16	22 1/4	2 9/16	628
300	5 1/2	5 29/32	12 25/32	4 27/32	8 1/16	24 11/32	12	39 7/32	22 5/8	23 1/32	2 3/4	750
400	6 11/16	6 7/8	14 13/16	6 15/32	9 3/32	26 5/16	12 25/32	43 27/32	27 5/32	26 3/16	2 3/4	1235
500	7 3/32	7 9/32	15 21/32	6 15/32	10 3/32	28 9/32	13 25/32	46 27/32	28 11/32	27 15/16	2 3/4	1510
600	7 7/8	8 1/16	17 15/32	7 7/16	11 3/32	28 9/32	14 3/4	48 15/16	31 7/8	30 1/2	2 3/4	1940
700	8 9/32	8 15/32	17 7/8	8 1/32	12 1/8	28 9/32	15 3/4	49 23/32	34 1/4	32 9/32	2 3/4	2161
800	8 9/32	8 21/32	18 9/32	8 1/32	12 1/8	28 9/32	15 3/4	50	34 1/4	32 9/32	2 3/4	2425
900	8 21/32	9 1/16	19 3/32	8 15/32	12 29/32	28 9/32	16 17/32	51 1/32	36 7/32	33 27/32	2 3/4	2822
1000	9 7/16	9 7/16	20 9/32	8 15/32	13 3/4	28 9/32	16 17/32	52 19/32	37	35 7/16	2 3/4	3219
1250	10 1/4	10 5/8	23 1/32	9 1/16	14 17/32	30 1/4	17 23/32	57 5/16	40 11/32	38 3/16	2 3/4	4387
1500	11 1/32	11 13/32	24 19/32	9 1/16	14 17/32	32 7/32	17 23/32	61 1/4	40 11/32	39 3/4	2 3/4	5291

RFID CAD

* For shackles ≥ WLL 150 t



Green Pin® Wide Mouth Shackles

bow shackles with safety bolt

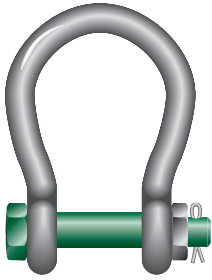

G-4263

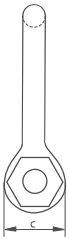
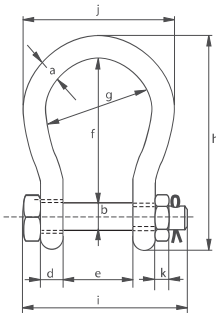

- **Material** : bow and pin alloy steel, Grade 8, quenched and tempered
- **Safety Factor** : MBL equals 6 x WLL
- **Finish** : hot dipped galvanized
- **Temperature Range** : -20 °C up to +200 °C
- **Certification** : 2.1 2.2 3.1 MTC^a CE

working load limit	diameter bow	diameter pin	diameter eye	width eye	width inside	length inside	width bow	length	length bolt	width	thickness nut	weight each
t	a	b	c	d	e	f	g	h	i	j	k	kg
4.75	22	25	52	22	63	112	88	173	157	132	22	2.08
6.5	25	28	59	25	75	135	105	204	183	155	25	3.14
8.5	28	32	66	28	82	148	115	225	205	171	27	4.36
9.5	32	35	72	32	90	162	126	248	224	190	30	5.95
12	35	38	79	35	100	180	140	274	245	210	33	7.87
16	38	42	88	38	106	216	159	319	248	235	19	12.5
25	45	50	103	45	127	248	175	370	296	265	23	16.7
30	50	57	118	50	146	273	207	411	332	307	26	25
55	65	70	145	65	165	314	213	487	391	343	32	45
75	83	83	164	83	184	330	254	537	460	420	39	70

In inch

working load limit	diameter bow	diameter pin	diameter eye	width eye	width inside	length inside	width bow	length	length bolt	width	thickness nut	weight each
t	a	b	c	d	e	f	g	h	i	j	k	lbs
4.75	7/8	1	2 1/16	7/8	2 15/32	4 13/32	3 15/32	6 13/16	6 3/16	5 3/16	7/8	4.59
6.5	1	1 1/8	2 5/16	31/32	2 15/16	5 5/16	4 1/8	8 1/32	7 7/32	6 3/32	31/32	6.92
8.5	1 1/8	1 1/4	2 19/32	1 3/32	3 7/32	5 13/16	4 17/32	8 27/32	8 1/16	6 23/32	1 1/16	9.61
9.5	1 1/4	1 3/8	2 27/32	1 1/4	3 17/32	6 3/8	4 31/32	9 3/4	8 13/16	7 15/32	1 3/16	13.12
12	1 3/8	1 1/2	3 1/8	1 3/8	3 15/16	7 3/32	5 1/2	10 25/32	9 21/32	8 9/32	1 5/16	17.35
16	1 1/2	1 5/8	3 15/32	1 1/2	4 3/16	8 1/2	6 1/4	12 9/16	9 3/4	9 1/4	3/4	27.56
25	1 3/4	2	4 1/16	1 25/32	5	9 3/4	6 7/8	14 9/16	11 21/32	10 7/16	29/32	36.82
30	2	2 1/4	4 21/32	1 31/32	5 3/4	10 3/4	8 5/32	16 3/16	13 1/16	12 3/32	1 1/32	55.12
55	2 1/2	2 3/4	5 23/32	2 9/16	6 1/2	12 3/8	8 3/8	19 3/16	15 13/32	13 1/2	1 1/4	105.82
75	3 1/4	3 1/4	6 15/32	3 9/32	7 1/4	13	10	21 5/32	18 1/8	16 17/32	1 17/32	154.32

RFID CAD

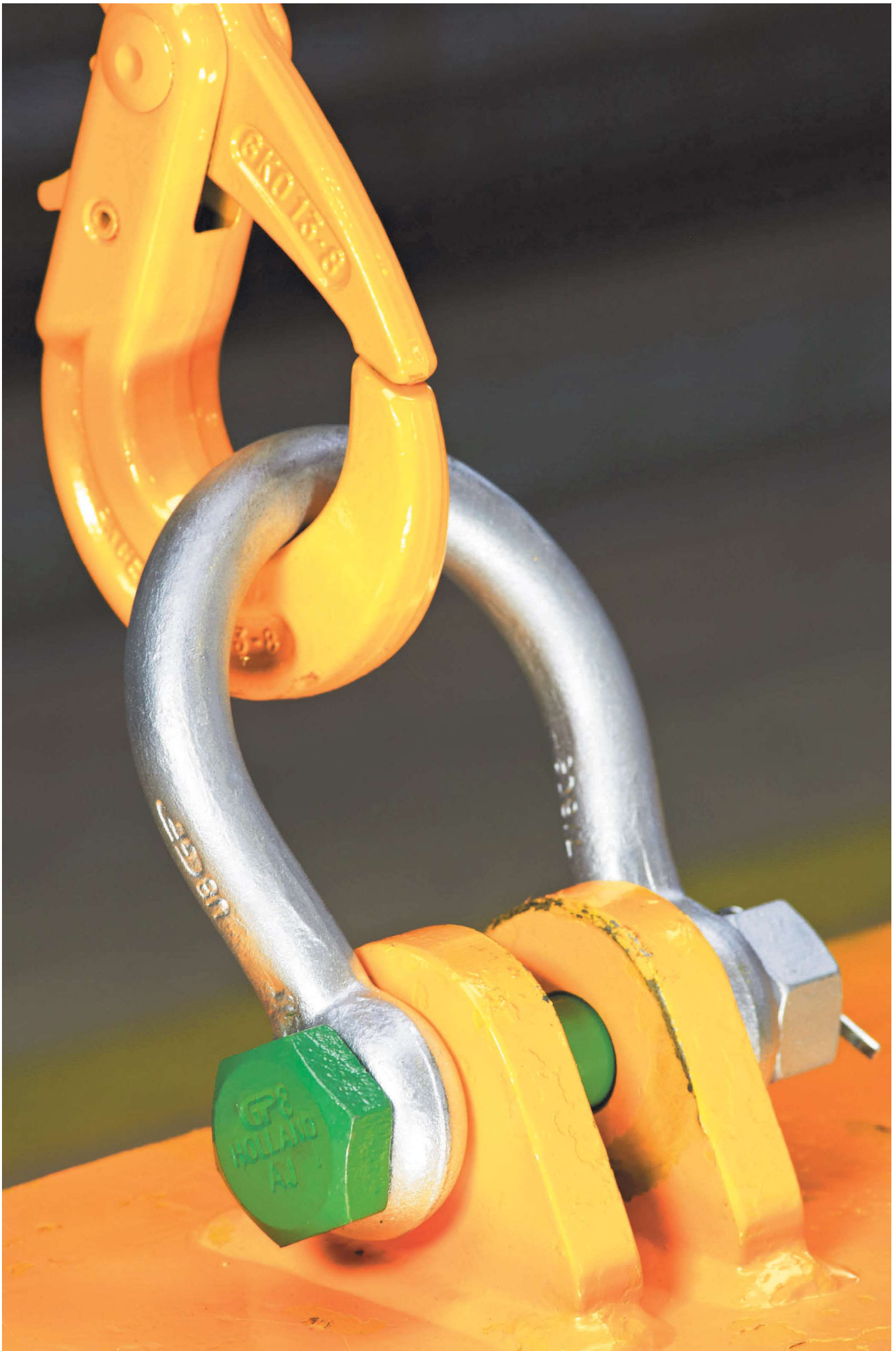

- 1
- 2
- 3
- 4
- 5
- 6
- 7
- 8
- 9
- 10
- 11
- 12
- 13
- 14
- 15
- 16
- 17
- 18
- 19
- 20

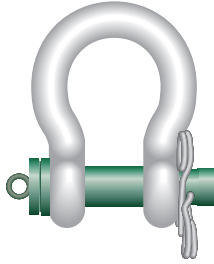

P-5363

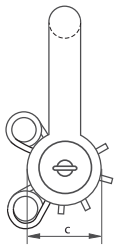
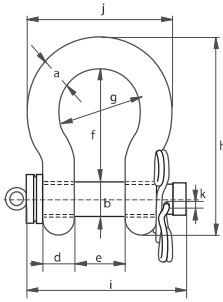

Green Pin® ROV Release

release shackles with spring pins

- **Material** : bow and pin alloy steel, Grade 8, Polar quality, quenched and tempered
- **Safety factor** : MBL equals 5 x WLL
- **Finish** : body painted white, pin painted green
- **Temperature Range** : -60°C up to +200°C
- **Certification** : 2.1 2.2 3.1 MTC^a CE
- **Note** : for in-line use only.
supplied without wires; design your own wiring plan

working load limit	diameter bow	diameter pin	diameter eye	width eye	width inside	length inside	width bow	length bow	length bolt	width	diameter	weight each
t	a	b	c	d	e	f	g	h	i	j	k	kg
6.5	22	25	52	22	36	83	58	144	130	102	5.5	1.7
9.5	28	32	66	28	47	108	75	185	166	131	6.5	3.4
12	32	35	72	32	51	115	83	201	184	147	6.5	4.7
17	38	42	88	38	60	146	99	249	202	175	6.5	8
25	45	50	103	45	74	178	126	300	243	216	8.5	13.6
35	50	57	116	50	83	197	138	334	269	238	8.5	19.1
42.5	57	65	130	57	95	222	160	377	301	274	8.5	28.3
55	65	70	145	65	105	260	180	433	329	310	8.5	38
85	75	83	162	75	127	329	190	527	375	340	8.5	60

In inch

working load limit	diameter bow	diameter pin	diameter eye	width eye	width inside	length inside	width bow	length bow	length bolt	width	diameter	weight each
t	a	b	c	d	e	f	g	h	i	j	k	lbs
6.5	7/8	1	2 1/32	7/8	1 7/16	3 9/32	2 9/32	5 11/16	5 1/8	4	7/32	3.75
9.5	1 1/8	1 1/4	2 19/32	1 1/8	1 7/8	4 1/4	2 15/16	7 9/32	6 17/32	5 5/32	1/4	7.5
12	1 1/4	1 3/8	2 13/16	1 9/32	2	4 17/32	3 9/32	7 29/32	7 1/4	5 25/32	1/4	10.36
17	1 1/2	1 5/8	3 1/2	1 17/32	2 11/32	5 3/4	3 29/32	9 13/16	7 15/16	6 7/8	1/4	17.64
25	1 3/4	2	4 1/32	1 25/32	2 29/32	7	4 15/16	11 13/16	9 19/32	8 17/32	11/32	30.0
35	2	2 1/4	4 9/16	1 31/32	3 9/32	7 3/4	5 7/16	13 5/32	10 19/32	9 3/8	11/32	42.1
42.5	2 1/4	2 9/16	5 1/8	2 1/4	3 3/4	8 3/4	6 9/32	14 13/16	11 7/8	10 25/32	11/32	62.4
55	2 1/2	2 3/4	5 23/32	2 9/16	4 1/8	10 1/4	7 3/32	17 3/32	12 15/16	12 3/16	11/32	83.8
85	3	3 1/4	6 11/32	2 15/16	5	12 15/16	7 1/2	20 3/4	14 3/4	13 3/8	11/32	132.3

CAD INFO





Green Pin® ROV Shackles

release shackles with locking clamp

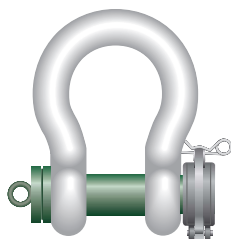

P-5365

- **Material** : bow and pin alloy steel, Grade 8, Polar quality, quenched and tempered
- **Safety Factor** : MBL equals 6 x WLL
for shackles with WLL 120 t and up the MBL equals 5x WLL
- **Finish** : body painted white, pin painted green
- **Temperature Range** : -60°C up to +200°C
- **Certification** : 2.1 2.2 3.1 MTC^a CE
- **Note** : supplied without wires; design your own wiring plan

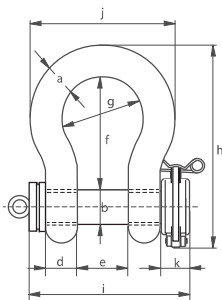

working load limit	diameter bow	diameter pin	diameter eye	width eye	width inside	length inside	width bow	length	length bolt	width	width locking clamp	weight each
t	a	b	c	d	e	f	g	h	i	j	k	kg
6.5	22	25	52	22	36	83	58	164	140	102	45	2.27
9.5	28	32	66	28	47	108	75	200	172	131	48	4.25
12	32	35	72	32	51	115	83	213	184	147	48	5.36
17	38	42	88	38	60	146	99	266	209	175	48	9.27
25	45	50	103	45	74	178	126	309	243	216	48	14.62
35	50	57	116	50	83	197	138	350	269	238	48	20.75
42.5	57	65	130	57	95	222	160	377	301	274	48	28.33
55	65	70	145	65	105	260	180	440	329	310	48	41
85	75	83	162	75	127	329	190	527	375	340	48	61
120	95	95	208	91	147	400	238	647	440	428	60	110
150	105	108	238	102	169	410	275	688	490	485	60	160
200	120	130	279	113	179	513	290	838	520	530	60	235
250	130	140	299	118	205	554	305	904	560	565	60	285

In inch

working load limit	diameter bow	diameter pin	diameter eye	width eye	width inside	length inside	width bow	length	length bolt	width	width locking clamp	weight each
t	a	b	c	d	e	f	g	h	i	j	k	lbs
6.5	7/8	1	2 1/32	7/8	1 7/16	3 9/32	2 9/32	6 7/16	5 17/32	4	1 25/32	5.00
9.5	1 1/8	1 1/4	2 19/32	1 1/8	1 7/8	4 1/4	2 15/16	7 7/8	6 3/4	5 5/32	1 29/32	9.37
12	1 1/4	1 3/8	2 13/16	1 9/32	2	4 17/32	3 9/32	8 3/8	7 1/4	5 25/32	1 29/32	11.82
17	1 1/2	1 5/8	3 1/2	1 17/32	2 11/32	5 3/4	3 29/32	10 1/2	8 1/4	6 7/8	1 29/32	20.44
25	1 3/4	2	4 1/32	1 25/32	2 29/32	7	4 15/16	12 5/32	9 19/32	8 17/32	1 29/32	32.23
35	2	2 1/4	4 9/16	1 31/32	3 9/32	7 3/4	5 7/16	13 25/32	10 19/32	9 3/8	1 29/32	45.75
42.5	2 1/4	2 9/16	5 1/8	2 1/4	3 3/4	8 3/4	6 9/32	14 13/16	11 7/8	10 25/32	1 29/32	62.5
55	2 1/2	2 3/4	5 23/32	2 9/16	4 1/8	10 1/4	7 3/32	17 11/32	12 15/16	12 3/16	1 29/32	90.4
85	3	3 1/4	6 11/32	2 15/16	5	12 15/16	7 1/2	20 3/4	14 3/4	13 3/8	1 29/32	134.5
120	3 3/4	3 3/4	8 3/16	3 19/32	5 25/32	15 3/4	9 3/8	25 1/2	17 11/32	16 7/8	2 11/32	243
150	4 1/8	4 1/4	9 3/8	4	6 5/8	16 5/32	10 13/16	27 3/32	19 5/16	19 1/8	2 11/32	353
200	4 23/32	5 1/8	11	4 7/16	7 1/32	20 3/16	11 7/16	33	20 1/2	20 7/8	2 11/32	518
250	5 1/8	5 1/2	11 25/32	4 5/8	8 3/32	21 13/16	12	35 19/32	22 1/32	22 1/4	2 11/32	628

CAD INFO



1
2
3
4
5
6
7
8
9
10
11
12
13
14
15
16
17
18
19
20

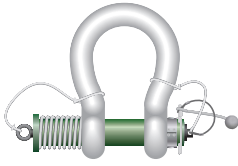

P-5367

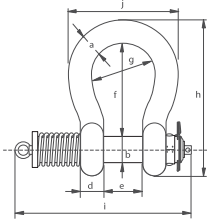

Green Pin® ROV Shackles

spring release shackles

- **Material** : bow and pin alloy steel, Grade 8, Polar quality, quenched and tempered
- **Safety factor** : MBL equals 5 x WLL
- **Finish** : body painted white, pin painted green
- **Temperature Range** : -40°C up to +200°C

• **Certification** : 2.1 2.2 3.1 MTC^a CE

- **Note** : for in-line use only.
this shackle is assembled with wire rope slings and monkey's fist for size starting from WLL 42.5 up to and including 150 t a special compression tool (sold separately) is required to assemble the shackle.

working load limit	diameter bow	diameter pin	diameter eye	width eye	width inside	length inside	width bow	length bow	length bolt	width	weight each
t	a	b	c	d	e	f	g	h	i	j	kg
12	32	35	72	32	51	115	83	201	291	147	5.24
13.5	35	38	80	35	57	133	92	227	301	162	7
17	38	42	88	38	60	146	99	249	360	175	9.25
25	45	50	103	45	74	178	126	300	370	216	15.5
35	50	57	116	50	83	197	138	334	400	238	20.4
42.5	57	65	130	57	95	222	160	377	460	274	39
55	65	70	145	65	105	260	180	433	490	310	42
85	75	83	162	75	127	329	190	527	587	340	67
120	95	95	208	91	147	399	238	646	687	428	123
150	105	108	238	102	169	410	275	688	727	485	168

In inch

working load limit	diameter bow	diameter pin	diameter eye	width eye	width inside	length inside	width bow	length bow	length bolt	width	weight each
t	a	b	c	d	e	f	g	h	i	j	lbs
12	1 1/4	1 3/8	2 13/16	1 9/32	2	4 17/32	3 9/32	7 29/32	11 1/2	5 25/32	11.55
13.5	1 3/8	1 1/2	3 5/32	1 3/8	2 1/4	5 1/4	3 5/8	8 15/16	11 7/8	6 11/32	15.43
17	1 1/2	1 5/8	3 1/2	1 17/32	2 11/32	5 3/4	3 29/32	9 13/16	14 5/32	6 7/8	20.39
25	1 3/4	2	4 1/32	1 25/32	2 29/32	7	4 15/16	11 19/16	14 9/16	8 17/32	34.2
35	2	2 1/4	4 9/16	1 31/32	3 9/32	7 3/4	5 7/16	13 5/32	15 3/4	9 3/8	45
42.5	2 1/4	2 9/16	5 1/8	2 1/4	3 3/4	8 3/4	6 9/32	14 13/16	18 1/8	10 25/32	86
55	2 1/2	2 3/4	5 23/32	2 9/16	4 1/8	10 1/4	7 3/32	17 3/32	19 5/16	12 3/16	92.6
85	3	3 1/4	6 11/32	2 15/16	5	12 15/16	7 1/2	20 3/4	23 1/8	13 3/8	147.7
120	3 3/4	3 3/4	8 3/16	3 19/32	5 25/32	15 23/32	9 3/8	25 7/16	27 1/32	16 7/8	271
150	4 1/8	4 1/4	9 3/8	4	6 5/8	16 5/32	10 13/16	27 3/32	28 19/32	19 1/8	370

CAD INFO



1
2
3
4
5
6
7
8
9
10
11
12
13
14
15
16
17
18
19
20

Compression Tool for ROV spring release shackles

- **Material** : mild steel
- **Finish** : black painted
- **Note** : required for ROV spring release shackle (type P-5367), for sizes WLL 42.5 t and up
- **Certification** : 2.1

P-5368

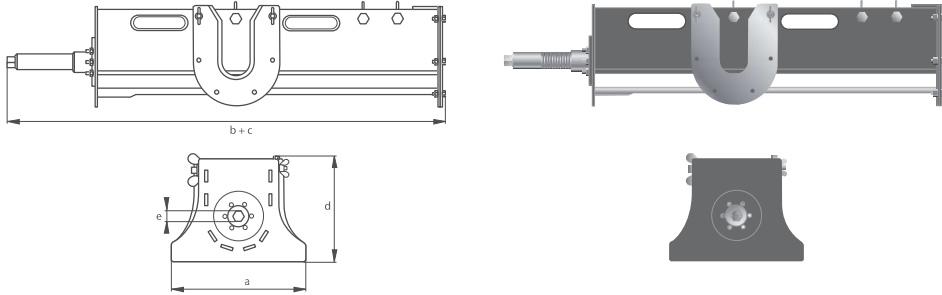

for shackle WLL	diameter bow	diameter pin	width	length closed position	length opened position	height	width	weight each
t	a mm	b mm	a mm	b mm	c mm	d mm	e mm	kg
42.5	57	65	300	1000	1500	225	24	34
55	65	70						
85	75	83						
120	95	95	340	1100	1750	285	24	42
150	105	108						

In inch

for shackle WLL	diameter bow	diameter pin	width	length closed position	length opened position	height	width	weight each
t	a inch	b inch	a inch	b inch	c inch	d inch	e inch	lbs
42.5	2 1/4	2 9/16	11 13/16	39 3/8	59 1/16	8 7/8	15/16	75
55	2 1/2	2 3/4						
85	3	3 1/4						
120	3 3/4	3 3/4	13 3/8	43 5/16	68 29/32	11 1/4	15/16	92.6
150	4 1/8	4 1/4						



Watch the DEMO on our **YouTube** channel

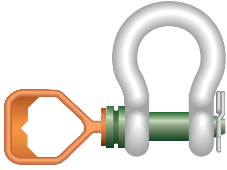

P-5361D

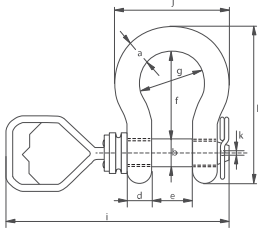

Green Pin® ROV Shackles

release & retrieve shackles with tapered pin and D-handle

- **Material** : bow and pin alloy steel, Grade 8, Polar quality, quenched and tempered
- **Safety factor** : MBL equals 5 x WLL
- **Finish** : body painted white, pin painted green
- **Temperature Range** : -60°C up to +200°C
- **Certification** : 2.1 2.2 3.1 MTC^a CE
- **Note** : supplied without wires; design your own wiring plan

working load limit	diameter bow	diameter pin	diameter eye	width eye	width inside	length inside	width bow	length	length bolt	width	diameter	weight each
tons	a	b	c	d	e	f	g	h	i	j	k	kg
6.5	22	25	52	22	36	83	58	144	345	102	3.5	1.50
9.5	28	32	66	28	47	108	75	185	381	131	5.5	3.16
12	32	35	72	32	51	115	83	201	393	147	6.5	4.31
17	38	42	88	38	60	146	99	249	417	175	8.5	7.43
25	45	50	103	45	74	178	126	300	464	216	8.5	12.84
35	50	57	111	50	83	197	138	331	484	238	8.5	18.15
42.5	57	65	130	57	95	222	160	377	516	274	7.5	26.29
55	65	70	145	65	105	260	180	433	545	310	7.5	37.60

In inch

working load limit	diameter bow	diameter pin	diameter eye	width eye	width inside	length inside	width bow	length	length bolt	width	diameter	weight each
tons	a	b	c	d	e	f	g	h	i	j	k	kg
6.5	7/8	1	2 1/16	7/8	1 7/16	3 9/32	2 9/32	5 21/32	13 19/32	4 1/32	1/8	3.31
9.5	1 1/8	1 1/4	2 19/32	1 1/8	1 7/8	4 1/4	2 15/16	7 9/32	15	5 5/32	7/32	6.97
12	1 1/4	1 3/8	2 27/32	1 9/32	2	4 17/32	3 9/32	7 29/32	15 15/32	5 25/32	1/4	9.49
17	1 1/2	1 5/8	3 15/32	1 17/32	2 11/32	5 3/4	3 29/32	9 13/16	16 13/32	6 7/8	1 1/32	16.37
25	1 3/4	2	4 1/16	1 25/32	2 29/32	7	4 15/16	11 13/16	18 9/32	8 1/2	1 1/32	28.31
35	2	2 1/4	4 3/8	1 31/32	3 9/32	7 3/4	5 7/16	13 1/32	19 1/16	9 3/8	1 1/32	40.01
42.5	2 1/4	2 9/16	5 1/8	2 1/4	3 3/4	8 3/4	6 9/32	14 27/32	20 5/16	10 25/32	9/32	57.96
55	2 1/2	2 3/4	5 23/32	2 9/16	4 1/8	10 1/4	7 9/32	17 1/16	21 15/32	12 7/32	9/32	82.89

INFO



Green Pin® ROV Shackles

release & retrieve shackles with tapered pin and fishtail-handle

- **Material** : bow and pin alloy steel, Grade 8, Polar quality, quenched and tempered
- **Safety factor** : MBL equals 5 x WLL
- **Finish** : body painted white, pin painted green
- **Temperature Range** : -60° C up to +200° C
- **Certification** : 2.1 2.2 3.1 MTC^a CE
- **Note** : supplied without wires; design your own wiring plan

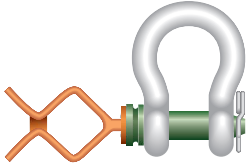

P-5361F

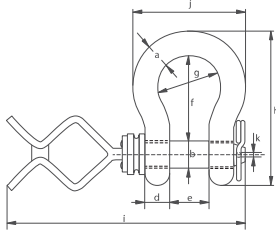

working load limit	diameter bow	diameter pin	diameter eye	width eye	width inside	length inside	width bow	length bow	length bolt	width	diameter	weight each
tons	a	b	c	d	e	f	g	h	i	j	k	kg
6.5	22	25	52	22	36	83	58	144	419	102	3.5	1.50
9.5	28	32	66	28	47	108	75	185	455	131	5.5	3.16
12	32	35	72	32	51	115	83	201	467	147	6.5	4.31
17	38	42	88	38	60	146	99	249	491	175	8.5	7.43
25	45	50	103	45	74	178	126	300	538	216	8.5	12.84
35	50	57	111	50	83	197	138	331	558	238	8.5	18.15
42.5	57	65	130	57	95	222	160	377	590	274	7.5	26.29
55	65	70	145	65	105	260	180	433	619	310	7.5	37.60

In inch

working load limit	diameter bow	diameter pin	diameter eye	width eye	width inside	length inside	width bow	length bow	length bolt	width	diameter	weight each
tons	a	b	c	d	e	f	g	h	i	j	k	kg
6.5	7/8	1	2 1/16	7/8	1 7/16	3 9/32	2 9/32	5 21/32	16 1/2	4 1/32	1/8	3.31
9.5	1 1/8	1 1/4	2 19/32	1 1/8	1 7/8	4 1/4	2 15/16	7 9/32	17 29/32	5 5/32	7/32	6.97
12	1 1/4	1 3/8	2 27/32	1 9/32	2	4 17/32	3 9/32	7 29/32	18 3/8	5 25/32	1/4	9.49
17	1 1/2	1 5/8	3 15/32	1 17/32	2 11/32	5 3/4	3 29/32	9 13/16	19 11/32	6 7/8	11/32	16.37
25	1 3/4	2	4 1/16	1 25/32	2 29/32	7	4 15/16	11 13/16	21 3/16	8 1/2	11/32	28.31
35	2	2 1/4	4 3/8	1 31/32	3 9/32	7 3/4	5 7/16	13 1/32	21 31/32	9 3/8	11/32	40.01
42.5	2 1/4	2 9/16	5 1/8	2 1/4	3 3/4	8 3/4	6 9/32	14 27/32	23 7/32	10 25/32	9/32	57.96
55	2 1/2	2 3/4	5 23/32	2 9/16	4 1/8	10 1/4	7 9/32	17 1/16	24 3/8	12 7/32	9/32	82.89

INFO



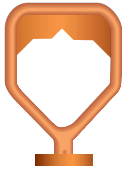

P-5396D

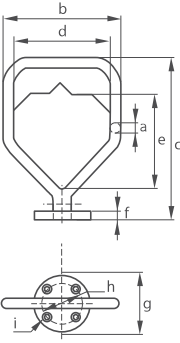

Green Pin® D-handle

- Material : casted steel
- Finish : painted orange
- Certification : 2.1

diameter	width	length	width	length inside	thickness	diameter	diameter	diameter	weight each
a	b	c	d	e	f	g	h	i	kg
19	153	215	115	110	10	70	48	8.5	1.70

In inch

diameter	width	length	width	length inside	thickness	diameter	diameter	diameter	weight each
a	b	c	d	e	f	g	h	i	kg
$\frac{3}{4}$	$6 \frac{1}{32}$	$8 \frac{15}{32}$	$4 \frac{17}{32}$	$4 \frac{11}{32}$	$\frac{13}{32}$	$2 \frac{3}{4}$	$1 \frac{7}{8}$	$\frac{11}{32}$	3.75

Green Pin® Fishtail-handle

- Material : casted steel
- Finish : painted orange
- Certification : 2.1

diameter	width	length	width	length inside	thickness	diameter	diameter	diameter	weight each
a	b	c	d	e	f	g	h	i	kg
19	178	289	21	133	10	70	48	8.5	1.92

In inch

diameter	width	length	width	length inside	thickness	diameter	diameter	diameter	weight each
a	b	c	d	e	f	g	h	i	kg
$\frac{3}{4}$	7	$11 \frac{3}{8}$	$\frac{13}{16}$	$5 \frac{1}{4}$	$\frac{13}{32}$	$2 \frac{3}{4}$	$1 \frac{7}{8}$	$\frac{11}{32}$	4.23

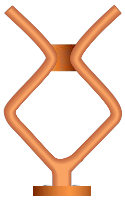

P-5396F

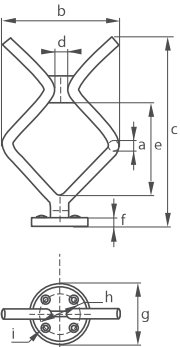

1
2
3
4
5
6
7
8
9
10
11
12
13
14
15
16
17
18
19
20



- 1
- 2
- 3
- 4
- 5
- 6
- 7
- 8
- 9
- 10
- 11
- 12
- 13
- 14
- 15
- 16
- 17
- 18
- 19
- 20

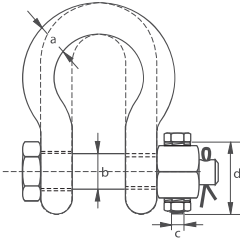
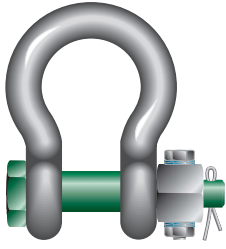

Green Pin® Fixed Nut Shackles

Shackles can also be used in more permanent constructions. These can be subject to dynamic loads and/or extreme vibrations. In such applications there is a risk that, over time, the nut starts moving over the thread. To avoid this risk we offer our range of Green Pin® Fixed Nut Shackles.

Green Pin® Standard, Polar and Super shackles can be equipped with an extra AISI 316 securing bolt which is drilled through the nut and shackle pin. This securing bolt is fastened with two sets of Nord-Lock® washers and a securing nut. This will keep the shackle nut in position. The Nord-Lock wedge-locking washers lock when subjected to extreme vibration or dynamic loads.

Green Pin® Fixed Nut Shackles are available on request.

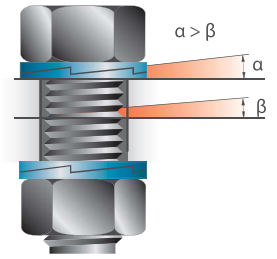

Green Pin® Fixed Nut Shackles

- G-4143 - Green Pin® Fixed Nut Standard Shackles, bow shackles with safety bolt and fixed nut
- G-4133 - Green Pin® Fixed Nut Standard Shackles, dee shackles with safety bolt and fixed nut
- G-5143 - Green Pin® Fixed Nut Polar Shackles, bow shackles with safety bolt and fixed nut
- G-5243 - Green Pin® Fixed Nut Super Shackles, bow shackles with safety bolt and fixed nut

G-4143 Safety bow WLL	G-4133 Safety dee WLL	G-5143 Polar WLL	G-5243 Super WLL	diameter body	diameter pin	securing bolt thread	securing bolt length	torque
t	t	t	t	a mm	b mm	c mm	d mm	Nm
2	2	2	3,3	13,5	16	M6	35	9,2
3,25	3,25	3,25	5	16	19	M6	40	9,2
4,75	4,75	4,75	7	19	22	M6	45	9,2
6,5	6,5	6,5	9,5	22	25	M8	50	22
8,5	8,5	8,5	12,5	25	28	M8	55	22
9,5	9,5	9,5	15	28	32	M10	60	43
12	12	12	18	32	35	M10	65	43
13,5	13,5	13,5	21	35	38	M10	70	43
17	17	17	30	38	42	M8	75	22
25	25	25	40	45	50	M8	90	22
35	35	35	55	50	57	M10	100	43
				57	57	M10	100	43
42,5	42,5	42,5		57	65	M12	110	75
55	55	55		65	70	M12	120	75
			85	70	70	M12	120	75
85	85	85		75	83	M12	140	75
			120	83	83	M12	140	75

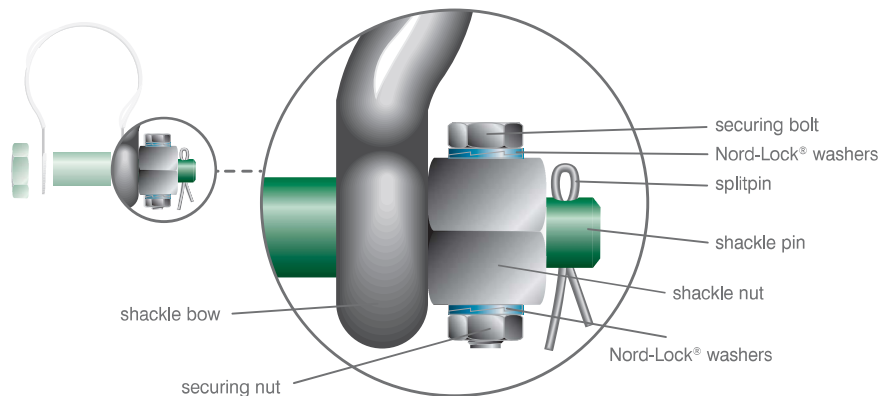

Green Pin® Shackles with RFID

All lifting equipment requires regular inspection. Tracking and filing reports on paper can be a time consuming task. Van Beest now offers a solution with an easily accessible RFID (Radio Frequency Identification) chip in our range of Green Pin® Shackles.

This RFID chip responds to a radio-signal that is transmitted by a reader. Each chip has a unique number and this number links the individual shackle to a record in an inspection management system.

The chips are impact resistant and durable and they are countersunk into the end of the shackle pin. The chips are NFC (Near Field Communication) compatible, allowing users to scan, identify and track the shackles with the latest generation of NFC compatible smartphones.

Van Beest offers the option of RFID implementation in all Green Pin® shackles with a minimum pin diameter of 28mm.



RF Protocol : ISO 15693
Operating Frequency : HF – 13.56 MHz

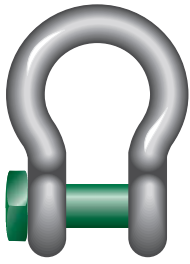

G-4164

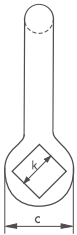
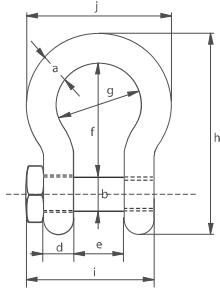

Green Pin® Trawling Shackles

bow shackles with square headed screw pin

- **Material** : bow and pin high tensile steel, Grade 6, quenched and tempered
- **Safety Factor** : MBL equals 6 x WLL
- **Standard** : EN 13889 and
meets performance requirements of US Fed. Spec. RR-C-271, Grade A
- **Finish** : hot dipped galvanized
- **Certification** : 2.1 2.2 3.1 MTC^a CE

working load limit	diameter bow	diameter pin	diameter eye	width eye	width inside	length inside	width bow	length	length bolt	width	width bolt head	weight each
t	a	b	c	d	e	f	g	h	i	j	k	kg
2	13.5	16	34	13	22	51	32	89	57.5	58	22	0.34
3.25	16	19	40	16	27	64	43	110	71	75	27	0.63
4.75	19	22	46	19	31	76	51	129	82	89	32	1
6.5	22	25	52	22	36	83	58	144	93	102	32	1.44
8.5	25	28	59	25	43	95	68	164	108	118	36	2.21
9.5	28	32	66	28	47	108	75	185	120	131	41	3.18
12	32	35	72	32	51	115	83	201	137	147	50	4.32
13.5	35	38	80	35	57	133	92	227	149	162	50	5.67
17	38	42	88	38	60	146	99	249	164	175	60	7.36
25	45	50	103	45	74	178	126	300	192	216	60	12.38

In inch

working load limit	diameter bow	diameter pin	diameter eye	width eye	width inside	length inside	width bow	length	length bolt	width	width bolt head	weight each
t	a	b	c	d	e	f	g	h	i	j	k	lbs
2	1/2	5/8	1 11/32	1/2	7/8	2	1 1/4	3 1/2	2 1/4	2 9/32	7/8	0.75
3.25	5/8	3/4	1 9/16	5/8	1 1/16	2 17/32	1 11/16	4 11/32	2 25/32	2 15/16	1 1/16	1.39
4.75	3/4	7/8	1 13/16	3/4	1 7/32	3	2	5 3/32	3 7/32	3 1/2	1 1/4	2.21
6.5	7/8	1	2 1/16	7/8	1 13/32	3 9/32	2 9/32	5 21/32	3 21/32	4 1/32	1 1/4	3.17
8.5	1	1 1/8	2 5/16	31/32	1 11/16	3 3/4	2 11/16	6 15/32	4 1/4	4 21/32	1 13/32	4.86
9.5	1 1/8	1 1/4	2 19/32	1 3/32	1 27/32	4 1/4	2 15/16	7 9/32	4 23/32	5 5/32	1 5/8	7.01
12	1 1/4	1 3/8	2 27/32	1 1/4	2	4 17/32	3 9/32	7 29/32	5 13/32	5 25/32	1 31/32	9.52
13.5	1 3/8	1 1/2	3 5/32	1 3/8	2 1/4	5 1/4	3 5/8	8 15/16	5 7/8	6 3/8	1 31/32	12.49
17	1 1/2	1 5/8	3 15/32	1 1/2	2 3/8	5 3/4	3 29/32	9 13/16	6 15/32	6 7/8	2 3/8	16.23
25	1 3/4	2	4 1/16	1 25/32	2 29/32	7	4 31/32	11 13/26	7 9/16	8 1/2	2 3/8	27.29

Green Pin® Trawling Shackles

dee shackles with square headed screw pin



G-4154

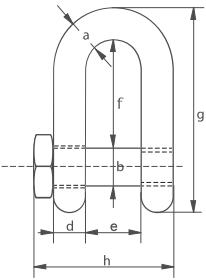

- **Material** : bow and pin high tensile steel, Grade 6, quenched and tempered
- **Safety Factor** : MBL equals 6 x WLL
- **Standard** : EN 13889 and meets performance requirements of US Fed. Spec. RR-C-271, Grade A
- **Finish** : hot dipped galvanized
- **Certification** : 2.1 2.2 3.1 MTC^a CE

working load limit	diameter bow	diameter pin	diameter eye	width eye	width inside	length inside	length	length bolt	width bolt head	weight each
t	a mm	b mm	c mm	d mm	e mm	f mm	g mm	h mm	i mm	kg
2	13.5	16	34	13	22	43	81	57.5	22	0.32
3.25	16	19	40	16	27	51	97	71	27	0.58
4.75	19	22	46	19	31	59	112	82	32	0.92
6.5	22	25	52	22	36	73	134	93	32	1.33
8.5	25	28	59	25	43	85	154	108	36	2.03
9.5	28	32	66	28	47	90	167	120	41	2.88
12	32	35	72	32	51	94	180	137	50	3.96
13.5	35	38	80	35	57	115	209	149	50	5.24
17	38	42	88	38	60	127	230	164	60	6.8
25	45	50	103	45	74	149	271	192	60	11.22

In inch

working load limit	diameter bow	diameter pin	diameter eye	width eye	width inside	length inside	length	length bolt	width bolt head	weight each
t	a inch	b inch	c inch	d inch	e inch	f inch	g inch	h inch	i inch	lbs
2	1/2	5/8	1 11/32	1/2	7/8	1 11/16	3 3/16	2 1/4	7/8	0.7
3.25	5/8	3/4	1 9/16	5/8	1 1/16	2	3 13/16	2 25/32	1 1/16	1.28
4.75	3/4	7/8	1 13/16	3/4	1 7/32	2 5/16	4 13/32	3 7/32	1 1/4	2.03
6.5	7/8	1	2 1/16	7/8	1 13/32	2 7/8	5 9/32	3 21/32	1 1/4	2.93
8.5	1	1 1/8	2 5/16	31/32	1 11/16	3 11/32	6 1/16	4 1/4	1 13/32	4.48
9.5	1 1/8	1 1/4	2 19/32	1 3/32	1 27/32	3 17/32	6 9/16	4 23/32	1 5/8	6.35
12	1 1/4	1 3/8	2 27/32	1 1/4	2	3 11/16	7 3/32	5 13/32	1 31/32	8.72
13.5	1 3/8	1 1/2	3 5/32	1 3/8	2 1/4	4 17/32	8 7/32	5 7/8	1 31/32	11.56
17	1 1/2	1 5/8	3 15/32	1 1/2	2 3/8	5	9 1/16	6 15/32	2 3/8	15
25	1 3/4	2	4 1/16	1 25/32	2 29/32	5 7/8	10 21/32	7 9/16	2 3/8	24.74



Green Pin® Sunken Hole Shackles

bow shackles with square sunken hole screw pin



G-4169

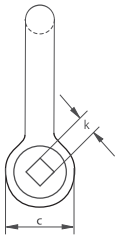
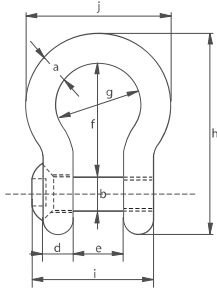

P-4170

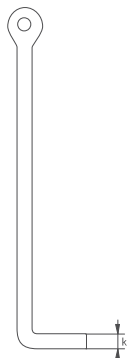

- **Material** : bow and pin high tensile steel, Grade 6, quenched and tempered
- **Safety Factor** : MBL equals 6 x WLL
- **Standard** : EN 13889 and
meets performance requirements of US Fed. Spec. RR-C-271, Grade A
- **Finish** : hot dipped galvanized
- **Certification** : 2.1 2.2 3.1 MTC^a CE
- **Note** : key for unscrewing the pin must be ordered separately

working load limit	diameter bow	diameter pin	diameter eye	width eye	width inside	length inside	width bow	length	length bolt	width	size hole	weight each
t	a	b	c	d	e	f	g	h	i	j	k	kg
2	13,5	16	34	13	22	51	32	89	51	58	11	0.31
3.25	16	19	40	16	27	64	43	110	63	75	11	0.56
4.75	19	22	46	19	31	76	51	129	74	89	11	0.98
6.5	22	25	52	22	36	83	58	144	85	102	13	1.46
8.5	25	28	59	25	43	95	68	164	99	118	13	2.18
9.5	28	32	66	28	47	108	75	185	110	131	17	3.06
12	32	35	72	32	51	115	83	201	122	147	17	4.24
13.5	35	38	80	35	57	133	92	227	135	162	17	5.59
17	38	42	88	38	60	146	99	249	145	175	17	7.37

In inch

working load limit	diameter bow	diameter pin	diameter eye	width eye	width inside	length inside	width bow	length	length bolt	width	size hole	weight each
t	a	b	c	d	e	f	g	h	i	j	k	lbs
2	1/2	5/8	1 11/32	1/2	7/8	2	1 1/4	3 1/2	2	2 9/32	7/16	0.68
3.25	5/8	3/4	1 9/16	5/8	1 1/16	2 17/32	1 11/16	4 11/32	2 15/32	2 15/16	7/16	1.23
4.75	3/4	7/8	1 13/16	3/4	1 7/32	3	2	5 3/32	2 29/32	3 1/2	7/16	2.16
6.5	7/8	1	2 1/16	7/8	1 13/32	3 9/32	2 9/32	5 21/32	3 11/32	4 1/32	1/2	3.22
8.5	1	1 1/8	2 5/16	31/32	1 11/16	3 3/4	2 11/16	6 15/32	3 29/32	4 21/32	1/2	4.81
9.5	1 1/8	1 1/4	2 19/32	1 3/32	1 27/32	4 1/4	2 15/16	7 9/32	4 11/32	5 5/32	21/32	6.75
12	1 1/4	1 3/8	2 27/32	1 1/4	2	4 17/32	3 9/32	7 29/32	4 13/16	5 25/32	21/32	9.35
13.5	1 3/8	1 1/2	3 5/32	1 3/8	2 1/4	5 1/4	3 5/8	8 15/16	5 5/16	6 3/8	21/32	12.32
17	1 1/2	1 5/8	3 15/32	1 1/2	2 3/8	5 3/4	3 29/32	9 13/16	5 23/32	6 7/8	21/32	16.25

Green Pin® Sunken Hole Shackles

dee shackles with square sunken hole screw pin



G-4159

- **Material** : bow and pin high tensile steel, Grade 6, quenched and tempered
- **Safety Factor** : MBL equals 6 x WLL
- **Standard** : EN 13889 and meets performance requirements of US Fed. Spec. RR-C-271, Grade A
- **Finish** : hot dipped galvanized
- **Certification** : 2.1 2.2 3.1 MTC^a CE
- **Note** : key for unscrewing the pin must be ordered separately

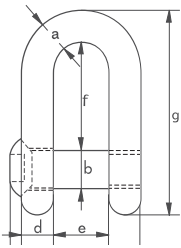

working load limit	diameter bow	diameter pin	diameter eye	width eye	width inside	length inside	length	length bolt	size hole	weight each
t	a	b	c	d	e	f	g	h	i	kg
2	13.5	16	34	13	22	43	81	51	11	0.34
3.25	16	19	40	16	27	51	97	63	11	0.6
4.75	19	22	46	19	31	59	112	74	11	0.98
6.5	22	25	52	22	36	73	134	85	13	1.26
8.5	25	28	59	25	43	85	154	99	13	2.14
9.5	28	32	66	28	47	90	167	110	17	3.05
12	32	35	72	32	51	94	180	122	17	3.56
13.5	35	38	80	35	57	115	209	135	17	5.17
17	38	42	88	38	60	127	230	145	17	6.84



In inch



P-4170

working load limit	diameter bow	diameter pin	diameter eye	width eye	width inside	length inside	length	length bolt	size hole	weight each
t	a	b	c	d	e	f	g	h	i	lbs
2	1/2	5/8	1 11/32	1/2	7/8	1 11/16	3 3/16	2	7/16	0.75
3.25	5/8	3/4	1 9/16	5/8	1 1/16	2	3 13/16	2 15/32	7/16	1.33
4.75	3/4	7/8	1 13/16	3/4	1 7/32	2 5/16	4 13/32	2 29/32	7/16	2.15
6.5	7/8	1	2 1/16	7/8	1 13/32	2 7/8	5 9/32	3 11/32	1/2	2.77
8.5	1	1 1/8	2 5/16	31/32	1 11/16	3 11/32	6 1/16	3 29/32	1/2	4.72
9.5	1 1/8	1 1/4	2 19/32	1 3/32	1 27/32	3 17/32	6 9/16	4 11/32	21/32	6.72
12	1 1/4	1 3/8	2 27/32	1 1/4	2	3 11/16	7 3/32	4 13/16	21/32	7.84
13.5	1 3/8	1 1/2	3 5/32	1 3/8	2 1/4	4 17/32	8 7/32	5 5/16	21/32	11.4
17	1 1/2	1 5/8	3 15/32	1 1/2	2 3/8	5	9 1/16	5 23/32	21/32	15.08

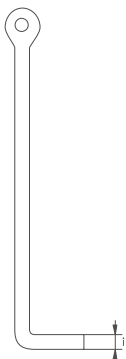



P-3764

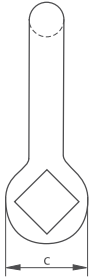
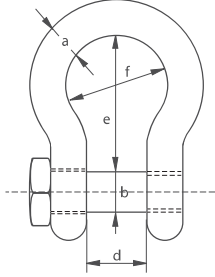

P-3754

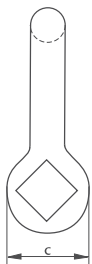
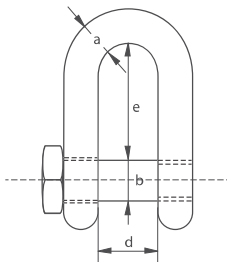

Fishing Shackles

bow shackles with square head screw pin

- **Material** : mild steel
- **Safety factor** : MBL equals 5 x WLL
- **Finish** : painted blue
- **Certification** : 2.1 2.2

working load limit	diameter bow	diameter pin	diameter eye	width inside	length inside	width bow	weight each
tons	a mm	b mm	c mm	d mm	e mm	f mm	kg
1.5	13	16	32	25	48	36	0.37
2.5	16	20	40	32	64	48	0.71
3	20	22	48	38	79	60	1.24
4	22	25	53	44	87	66	1.68
5	25	28	60	51	100	75	2.42
6.5	28	32	67	56	114	86	3.42
8	32	36	71	64	126	96	4.85
9	36	38	76	70	140	105	6.32

Fishing Shackles

dee shackles with square head screw pin

- **Material** : mild steel
- **Safety factor** : MBL equals 5 x WLL
- **Finish** : painted blue
- **Certification** : 2.1 2.2

working load limit	diameter bow	diameter pin	diameter eye	width inside	length inside	weight each
tons	a mm	b mm	c mm	d mm	e mm	kg
1.5	13	16	32	25	48	0.36
2.5	16	20	40	32	64	0.69
3	20	22	48	38	75	1.18
4	22	25	53	44	83	1.61
5	25	28	60	51	100	2.35
6.5	28	32	67	56	104	3.22
8	32	36	71	64	120	4.63
9	36	38	76	70	131	5.96

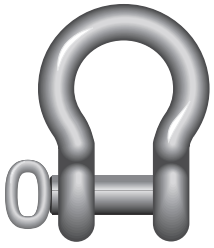

S-1165

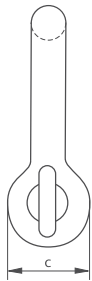
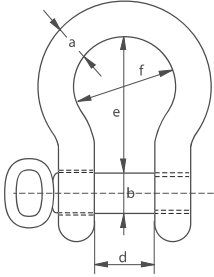

Mooring Shackles

bow shackles with screw pin

- **Material** : mild steel, untreated, Grade 3
- **Finish** : self coloured
- **Note** : not to be used for lifting applications
- **Certification** : 2.1

diameter bow	diameter pin	diameter eye	width inside	length inside	width bow	weight each
a	b	c	d	e	f	kg
mm	mm	mm	mm	mm	mm	
32	32	74	64	134	96	4.2
38	38	89	76	160	114	7.8
45	45	104	90	189	135	12.5
50	50	111	100	210	155	17.4
65	65	145	130	273	195	35.6



S-3351
G-3351

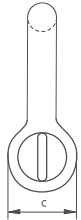
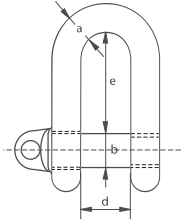

Shackles generally to DIN 82101 type A

dee shackles with screw collar pin

- **Material** : bow and pin high tensile steel, Grade 4
- **Safety Factor** : MBL equals 5 x WLL
- **Standard** : generally to DIN 82101 type A
- **Finish** : hot dipped galvanized or self coloured
- **Certification** : 2.1 2.2 CE
- **Note** : shackle no. 0.1 is electro-galvanized and will not have any markings as it is too small

no.	working load limit	diameter bow	diameter pin	diameter eye	width inside	length inside	weight each
	t	a mm	b mm	c mm	d mm	e mm	kg
0.1	0.1	5	5	10	7	15.5	0.02
0.16	0.16	6	6	12	8	18	0.02
0.25	0.25	8	8	16	11	24	0.05
0.4	0.4	10	10	20	14	30	0.1
0.6	0.63	12	12	24	17	36	0.18
1	1	13	16	32	21	49	0.3
1.6	1.6	16	20	40	27	61	0.57
2	2	20	22	44	30	67	0.98
2.5	2.5	22	24	48	33	73	1.3
3	3.15	25	27	54	38	83.5	1.85
4	4	28	30	60	42	91	2.53
5	5	32	36	72	47	111	4
6	6.3	36	39	78	53	119.5	5.3
8	8	41	45	90	60	139.5	7.9
10	10	44	48	96	66	147	10
12	12	49	52	104	73	158	13.5
16	16	55	60	120	81	185	19.2
20	20	61	68	136	90	211	28
25	25	67	72	144	100	221	34

Shackles generally to DIN 82101 type B

dee shackles with counter sunk screw pin

- **Material** : bow and pin high tensile steel, Grade 4
- **Safety Factor** : MBL equals 5 x WLL
- **Standard** : generally to DIN 82101 type B
- **Finish** : hot dipped galvanized or self coloured
- **Certification** : 2.1 2.2 CE
- **Note** : shackle no. 0.1 is electro-galvanized and will not have any markings as it is too small

no.	working load limit	diameter bow	diameter pin	diameter eye	width inside	length inside	weight each
	t	a mm	b mm	c mm	d mm	e mm	kg
0.1	0.1	5	5	10	7	15.5	0.01
0.16	0.16	6	6	12	8	18	0.02
0.25	0.25	8	8	16	11	24	0.05
0.4	0.4	10	10	20	14	30	0.09
0.6	0.63	12	12	24	17	36	0.17
1	1	13	16	32	21	49	0.29
1.6	1.6	16	20	40	27	61	0.54
2	2	20	22	44	30	67	0.98
2.5	2.5	22	24	48	33	73	1.23
3	3.15	25	27	54	38	83.5	1.8
4	4	28	30	60	42	91	2.6
5	5	32	36	72	47	111	3.8
6	6.3	36	39	78	53	119.5	5.2
8	8	41	45	90	60	139.5	7.6
10	10	44	48	96	66	147	9.7

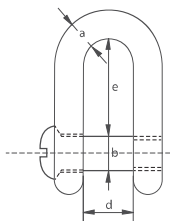

Shackles generally to DIN 82101 type C

dee shackles with safety bolt

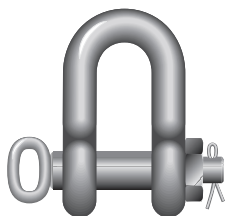

S-3356
G-3356

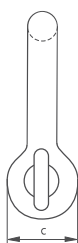
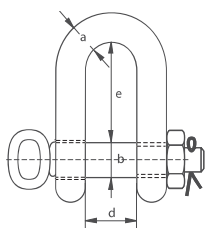
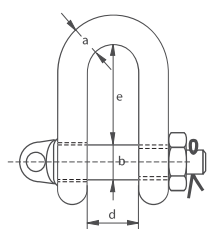

- **Material** : bow and pin high tensile steel, Grade 4
- **Safety Factor** : MBL equals 5 x WLL
- **Standard** : generally to DIN 82101 type C
- **Finish** : hot dipped galvanized or self coloured
- **Certification** : 2.1 2.2 CE
- **Note** : with screw collar pin : up to size no. 25
with hand-grip : from size no. 32

no.	working load limit	diameter bow	diameter pin	diameter eye	width inside	length inside	weight each
	t	a mm	b mm	c mm	d mm	e mm	kg
0.4	0.4	10	10	20	14	30	0.11
0.6	0.63	12	12	24	17	36	0.2
1	1	13	16	32	21	49	0.37
1.6	1.6	16	20	40	27	61	0.69
2	2	20	22	44	30	67	1.13
2.5	2.5	22	24	48	33	73	1.5
3	3.15	25	27	54	38	83.5	2.15
4	4	28	30	60	42	91	2.93
5	5	32	36	72	47	111	4.7
6	6.3	36	39	78	53	119.5	6.33
8	8	41	45	90	60	139.5	8.6
10	10	44	48	96	66	147	10.8
12	12.5	49	52	104	73	158	14.4
16	16	55	60	120	81	185	20.5
20	20	61	68	136	90	211	27.9
25	25	67	72	144	100	221	36
32	32	74	80	160	110	246	49
40	40	75	90	180	125	276	70
50	50	88	100	200	140	307	100
63	63	96	110	220	155	339	140
80	80	110	125	250	175	385.5	200
100	100	125	140	280	200	430	280



G-3161

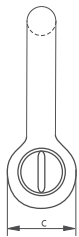
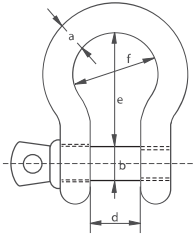

Yellow Pin Shackles

bow shackles with screw collar pin

- **Material** : bow and pin high tensile steel, Grade 6
- **Standard** : generally to US Fed. Spec. RR-C-271
- **Finish** : hot dipped galvanized
- **Certification** : 2.1 2.2 CE
- **Note** : import quality

working load limit	diameter bow	diameter pin	diameter eye	width inside	length inside	width bow	weight each
t	a mm	b mm	c mm	d mm	e mm	f mm	kg
0.33	5	6	14	9.5	22	15	0.03
0.5	6	8	16	12	29	20	0.05
0.75	8	10	19	13.5	31	21	0.08
1	10	11	23	17	37	26	0.14
1.5	11	13	27	19	43	29	0.2
2	13	16	30	20	48	33	0.33
3.25	16	19	38	27	60	43	0.62
4.75	19	22	46	32	71	50	1.07
6.5	22	25	53	36	84	58	1.62
8.5	25	28	61	43	95	68	2.28
9.5	28	32	68	46	108	74	3.36
12	32	35	76	51	119	82	4.31
13.5	35	38	84	57	133	92	6.14
17	38	42	92	60	146	98	7.81
25	45	50	106	73	177	127	12.61

Yellow Pin Shackles

bow shackles with safety bolt

- **Material** : bow and pin high tensile steel, Grade 6
- **Standard** : generally to US Fed. Spec. RR-C-271
- **Finish** : hot dipped galvanized
- **Certification** : 2.1 2.2 CE
- **Note** : import quality

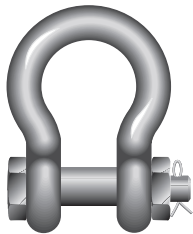

G-3163

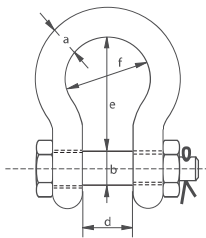

working load limit	diameter bow	diameter pin	diameter eye	width inside	length inside	width bow	weight each
t	a mm	b mm	c mm	d mm	e mm	f mm	kg
2	13	16	30	20	48	33	0.36
3.25	16	19	38	27	60	43	0.7
4.75	19	22	46	32	71	50	1.1
6.5	22	25	53	36	84	58	1.61
8.5	25	28	61	43	95	68	2.42
9.5	28	32	68	46	108	74	3.35
12	32	35	76	51	119	82	5.32
13.5	35	38	84	57	133	92	7.19
17	38	42	92	60	146	98	9.44
25	45	50	106	73	177	127	13.8



G-3151

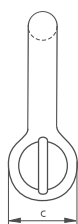
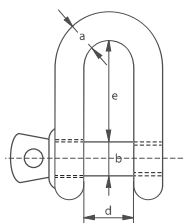

Yellow Pin Shackles

dee shackles with screw collar pin

- **Material** : bow and pin high tensile steel, Grade 6
- **Standard** : generally to US Fed. Spec. RR-C-271
- **Finish** : hot dipped galvanized
- **Certification** : 2.1 2.2 CE
- **Note** : import quality

working load limit	diameter bow	diameter pin	diameter eye	width inside	length inside	weight each
t	a mm	b mm	c mm	d mm	e mm	kg
0,33	5	6	12	9,5	19	0,03
0,5	6	8	16	12	22	0,04
0,75	8	10	19	13,5	26	0,08
1	10	11	23	17	32	0,13
1,5	11	13	27	19	37	0,2
2	13	16	30	20	41	0,28
3,25	16	19	38	27	51	0,57
4,75	19	22	46	32	60	1,19
6,5	22	25	53	36	71	1,43
8,5	25	28	61	43	81	2,16
9,5	28	32	68	46	90	3,06
12	32	35	76	51	100	4,11
13,5	35	38	84	57	111	5,28
17	38	42	92	60	122	6,69
25	45	50	106	73	146	12,14



G-3153

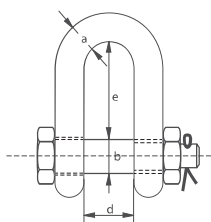

Yellow Pin Shackles

dee shackles with safety bolt

- **Material** : bow and pin high tensile steel, Grade 6
- **Standard** : generally to US Fed. Spec. RR-C-271
- **Finish** : hot dipped galvanized
- **Certification** : 2.1 2.2 CE
- **Note** : import quality

working load limit	diameter bow	diameter pin	diameter eye	width inside	length inside	weight each
t	a mm	b mm	c mm	d mm	e mm	kg
2	13	16	30	20	41	0,33
3,25	16	19	38	27	51	0,62
4,75	19	22	46	32	60	1,02
6,5	22	25	53	36	71	1,49
8,5	25	28	61	43	81	2,26
9,5	28	32	68	46	90	3,2
12	32	35	76	51	100	4,91
13,5	35	38	84	57	111	5,84
17	38	42	92	60	122	8,4
25	45	50	106	73	146	11,9

1

2

3

4

5

6

7

8

9

10

11

12

13

14

15

16

17

18

19

20



S-2761
E-2761
G-2761

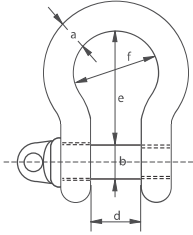

Shackles generally to B.S. 3032 table 3

large bow shackles with screw collar pin

- **Material** : bow and pin alloy steel, EN14a
- **Safety Factor** : MBL equals 4 x WLL
- **Standard** : generally to B.S. 3032 table 3
- **Finish** : hot dipped galvanized, electro-galvanized or self coloured
- **Certification** : 2.1 2.2 CE

working load limit	diameter bow	diameter pin	diameter eye	width inside	length inside	width bow	weight each
t	a mm	b mm	c mm	d mm	e mm	f mm	kg
0.15	6	10	19	13	28	19	0.12
0.45	10	13	25	16	41	25	0.18
0.75	13	16	32	22	54	32	0.37
1.25	16	19	38	28	70	41	0.72
2	19	22	44	35	86	51	1.20
2.75	22	25	51	41	98	57	1.85
3.75	25	28	57	44	108	64	2.61
4.75	28	32	63	51	124	73	3.78
5.75	32	35	70	57	137	83	5.17
7.25	35	38	76	63	152	89	6.46
8.5	38	44	89	70	168	98	8.34
9.5	42	48	94	76	187	111	11.1
11.5	44	51	102	86	206	121	14.5
13	48	54	108	92	222	130	17.8
15	51	57	114	98	238	140	25.5
18.5	57	63	127	105	257	152	34.4
20	60	67	133	111	273	162	36.8
25	67	73	146	121	302	178	45
30	73	79	159	133	330	197	62.2
35	79	86	171	146	359	213	81.8
40	86	92	184	159	387	229	95
50	95	102	203	171	429	254	131
65	108	117	235	197	483	286	194
80	117	127	254	216	533	308	274

1

2

3

4

5

6

7

8

9

10

11

12

13

14

15

16

17

18

19

20



S-2765
E-2765
G-2765

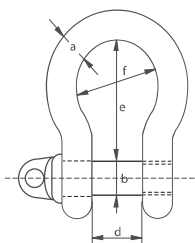

Shackles generally to B.S. 3032 table 4

small bow shackles with screw collar pin

- **Material** : bow and pin alloy steel, EN14a
- **Safety Factor** : MBL equals 4 x WLL
- **Standard** : generally to B.S. 3032 table 4
- **Finish** : hot dipped galvanized, electro-galvanized or self coloured
- **Certification** : 2.1 2.2 CE

working load limit	diameter bow	diameter pin	diameter eye	width inside	length inside	width bow	weight each
t	a mm	b mm	c mm	d mm	e mm	f mm	kg
0.2	6	10	19	13	25	16	0.11
0.5	10	13	25	16	38	22	0.17
1	13	16	32	22	51	29	0.35
1.5	16	19	38	28	64	38	0.66
2	19	22	44	35	76	44	1.06
3	22	25	51	38	89	51	1.68
4	25	28	57	44	102	60	2.47
5	28	32	63	51	114	67	3.48
6.25	32	35	70	57	127	76	4.79
7.5	35	38	76	60	140	83	5.95
9.25	38	44	89	67	152	89	7.55
10.5	41	48	95	73	165	98	9.79
12.5	44	51	102	79	178	105	12.5
14.25	48	54	108	86	191	114	15.3
16.5	51	57	114	92	203	121	21.8
18.5	54	60	121	95	216	127	28.9
20	57	63	127	105	229	137	30.9
25	63	70	140	114	254	152	37.8
30	70	79	159	127	279	168	52.6
35	76	86	171	137	305	184	69.5
40	79	89	178	143	318	191	78.1
50	89	98	203	159	356	213	109
65	102	114	229	184	406	244	163
80	114	127	254	206	457	273	235

1

2

3

4

5

6

7

8

9

10

11

12

13

14

15

16

17

18

19

20



S-2751
E-2751
G-2751

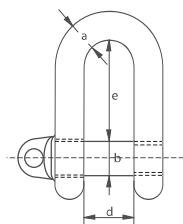

Shackles generally to B.S. 3032 table 2

large dee shackles with screw collar pin

- **Material** : bow and pin alloy steel, EN14a
- **Safety Factor** : MBL equals 4 x WLL
- **Standard** : generally to B.S. 3032 table 2
- **Finish** : hot dipped galvanized, electro-galvanized or self coloured
- **Certification** : 2.1 2.2 CE

working load limit	diameter bow	diameter pin	diameter eye	width inside	length inside	weight each
t	a mm	b mm	c mm	d mm	e mm	kg
0.25	6	10	19	13	25	0.11
0.5	10	13	25	19	38	0.17
0.75	13	16	32	28	54	0.35
1.5	16	19	38	32	64	0.66
2	19	22	44	38	73	1.02
3	22	25	51	44	83	1.57
3.75	25	28	57	51	95	2.3
5	28	32	64	54	105	3.2
6	32	35	70	60	114	4.3
7	35	38	76	67	127	5.4
9.5	38	45	83	70	137	6.8
11.25	42	48	89	76	146	8.7
13	44	51	95	83	156	11
14.25	48	54	108	92	178	14.3
16.25	51	57	114	98	187	20
18	54	60	121	105	197	26.4
20	57	64	127	108	210	28.3
25	64	73	146	121	235	35
30	70	79	159	133	260	49
35	76	86	171	146	279	63.6
40	79	89	178	149	292	71.7
50	89	102	203	171	330	101
65	102	114	229	191	375	151
80	114	127	254	219	419	215

- 1
- 2
- 3
- 4
- 5
- 6
- 7
- 8
- 9
- 10
- 11
- 12
- 13
- 14
- 15
- 16
- 17
- 18
- 19
- 20



S-2755
E-2755
G-2755

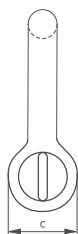
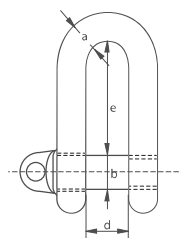

Shackles generally to B.S. 3032 table 1

small dee shackles with screw collar pin

- **Material** : bow and pin alloy steel, EN14a
- **Safety Factor** : MBL equals 4 x WLL
- **Standard** : generally to B.S. 3032 table 1
- **Finish** : hot dipped galvanized, electro-galvanized or self coloured
- **Certification** : 2.1 2.2 CE

working load limit	diameter bow	diameter pin	diameter eye	width inside	length inside	weight each
t	a mm	b mm	c mm	d mm	e mm	kg
0.3	6	10	19	9.5	22	0.1
0.6	10	13	25	16	35	0.16
1	13	16	32	22	48	0.31
1.75	16	19	38	25	57	0.59
2.5	19	22	44	32	70	0.98
3.5	22	25	51	35	83	1.55
4.5	25	28	57	38	92	2.2
5.5	28	32	64	44	105	3.1
7	32	35	70	48	114	4.2
8	35	38	83	54	127	5.1
10.75	38	45	89	60	140	6.6
13	42	48	95	64	149	8.1
14.75	44	51	102	70	162	10.5
16.75	48	54	108	73	171	13.3
19	51	57	114	76	184	19.2
20	54	60	121	83	197	22.4
25	60	70	140	92	219	25.3
30	64	73	146	98	229	31.5
35	70	79	159	108	254	47
40	73	83	165	111	264	60.2
50	83	95	190	127	298	68.5
65	92	108	216	140	333	98
80	102	117	235	156	368	147

1

2

3

4

5

6

7

8

9

10

11

12

13

14

15

16

17

18

19

20



S-1161
E-1161

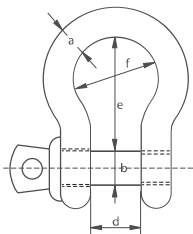

Commercial Shackles

bow shackles with screw collar pin

- **Material** : mild steel, untreated, Grade 3
- **Finish** : electro-galvanized or self coloured
- **Certification** : 2.1
- **Note** : not to be used for lifting applications

diameter bow	diameter pin	diameter eye	width inside	length inside	width bow	weight per 100 pcs
a mm	b mm	c mm	d mm	e mm	f mm	kg
5	5	10	10	20	15	1.4
6	6	12	12	24	18	2.4
8	8	16	16	32	24	5.4
10	10	20	20	40	30	10.6
11	11	22	22	44	33	16.4
12	12	24	24	48	36	19.4
14	14	28	28	56	42	44
16	16	32	32	64	48	44.2
19	19	38	38	76	57	82.8
22	22	44	44	88	66	116
25	25	50	50	100	75	168
28	28	56	56	112	84	232
32	32	64	64	128	96	382
38	38	76	76	152	114	623
45	45	90	90	180	135	1120
50	50	100	100	200	150	1536
57	57	114	114	228	171	2276
65	65	130	130	260	195	3375

Commercial Shackles

bow shackles with square head screw pin

- **Material** : mild steel, untreated, Grade 3
- **Finish** : self coloured
- **Certification** : 2.1
- **Note** : not to be used for lifting applications



S-1164

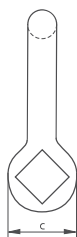
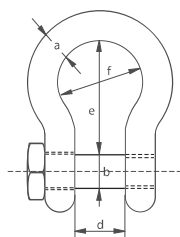

diameter bow	diameter pin	diameter eye	width inside	length inside	width bow	weight per 100 pcs
a mm	b mm	c mm	d mm	e mm	f mm	kg
6	6	12	12	24	18	2.7
8	8	16	16	32	24	6.4
10	10	20	20	40	30	12.5
11	11	22	22	44	33	16.6
12	12	24	24	48	36	21.6
14	14	28	28	56	42	34.3
16	16	32	32	64	48	51.2
19	19	38	38	76	57	100
22	22	44	44	88	66	133
25	25	50	50	100	75	195
28	28	56	56	112	84	275
32	32	64	64	128	96	410
38	38	76	76	152	114	686



S-1162
E-1162

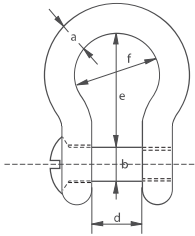

Commercial Shackles

bow shackles with counter sunk screw pin

- **Material** : mild steel, untreated, Grade 3
- **Finish** : electro-galvanized or self coloured
- **Certification** : 2.1
- **Note** : not to be used for lifting applications

diameter bow	diameter pin	diameter eye	width inside	length inside	width bow	weight per 100 pcs
a mm	b mm	c mm	d mm	e mm	f mm	kg
8	8	16	16	32	24	6
10	10	20	20	40	30	11.6
11	11	22	22	44	33	15.5
12	12	24	24	48	36	20.1
14	14	28	28	56	42	31.9
16	16	32	32	64	48	47.6
19	19	38	38	76	57	93.1
22	22	44	44	88	66	124
25	25	50	50	100	75	182

- 1
- 2
- 3
- 4
- 5
- 6
- 7
- 8
- 9
- 10
- 11
- 12
- 13
- 14
- 15
- 16
- 17
- 18
- 19
- 20



S-1151
E-1151

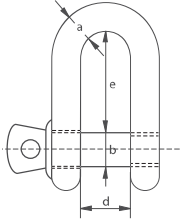

Commercial Shackles

dee shackles with screw collar pin

- **Material** : mild steel, untreated, Grade 3
- **Finish** : electro-galvanized or self coloured
- **Certification** : 2.1
- **Note** : not to be used for lifting applications

diameter bow	diameter pin	diameter eye	width inside	length inside	weight per 100 pcs
a	b	c	d	e	kg
mm	mm	mm	mm	mm	
5	5	10	10	20	1.4
6	6	12	12	24	2.2
8	8	16	16	32	5.2
10	10	20	20	40	11.8
11	11	22	22	44	14
12	12	24	24	48	20.5
14	14	28	28	56	29.4
16	16	32	32	64	42.6
19	19	38	38	76	72.6
22	22	44	44	88	108
25	25	50	50	100	185
28	28	56	56	112	226
32	32	64	64	128	358
38	38	76	76	152	602
45	45	90	90	180	1080
50	50	100	100	200	1480
57	57	114	114	228	2192
65	65	130	130	260	3252

Commercial Shackles

dee shackles with square head screw pin

- **Material** : mild steel, untreated, Grade 3
- **Finish** : self coloured
- **Certification** : 2.1
- **Note** : not to be used for lifting applications



S-1154

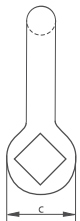
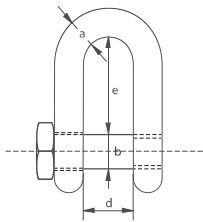

diameter bow	diameter pin	diameter eye	width inside	length inside	weight per 100 pcs
a	b	c	d	e	kg
mm	mm	mm	mm	mm	
6	6	12	12	24	2.6
8	8	16	16	32	6.17
10	10	20	20	40	12
11	11	22	22	44	16
12	12	24	24	48	20.8
14	14	28	28	56	33.1
16	16	32	32	64	49.4
19	19	38	38	76	96.4
22	22	44	44	88	128
25	25	50	50	100	188
28	28	56	56	112	265
32	32	64	64	128	395
38	38	76	76	152	661



S-1152
E-1152

Commercial Shackles

dee shackles with counter sunk screw pin

- **Material** : mild steel, untreated, Grade 3
- **Finish** : electro-galvanized or self coloured
- **Certification** : 2.1
- **Note** : not to be used for lifting applications

diameter bow	diameter pin	diameter eye	width inside	length inside	weight per 100 pcs
a	b	c	d	e	kg
mm	mm	mm	mm	mm	
8	8	16	16	32	5.72
10	10	20	20	40	9.6
11	11	22	22	44	14.9
12	12	24	24	48	19.3
14	14	28	28	56	30.7
16	16	32	32	64	45.8
19	19	38	38	76	89.5
22	22	44	44	88	119
25	25	50	50	100	175

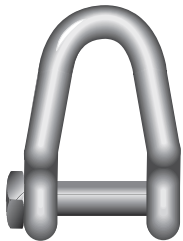
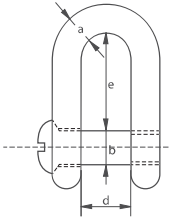

S-1170

Commercial Shackles

danlino V shackles with square head screw pin

- **Material** : mild steel, untreated, Grade 3
- **Finish** : self coloured
- **Certification** : 2.1
- **Note** : not to be used for lifting applications

diameter bow	diameter pin	diameter eye	width inside	length inside	weight per 100 pcs
a	b	c	d	e	kg
mm	mm	mm	mm	mm	
32	32	64	78	120	470

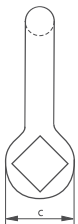
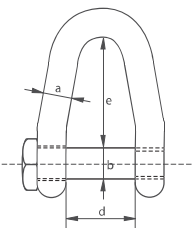

1
2
3
4
5
6
7
8
9
10
11
12
13
14
15
16
17
18
19
20